

SWATY COMET



Superabrasive grinding tools

RESIN, VITRIFIED, HYBRID and METAL BONDED,
ELECTROPLATED and VACUUM BRAZED TOOLS

Catalogue 2015



SWIATY COMET

	Pages		Pages
Manufacturing programme	5	1	METALWORKING INDUSTRY 20
Designation of grinding tools	6		Overview of grinding tools by their intended use, standard forms and
Standard shapes of grinding tools	7		recommendations 21-27
General features of the superabrasive grit and bond	8-15	1.1	Peripheral surface grinding and external cylindrical grinding 28-33
Instructions for the safe use of grinding tools	16-19	1.2	Internal cylindrical grinding 34-40
		1.3	Surface grinding 41-45
		1.4	Tool grinding and sharpening 46-58
		1.5	Tool grinding and sharpening in the wood industry 59-63
		1.6	Profile grinding 64-65
		1.7	CNC Tool grinding 66-68
		1.8	Cutting 69-71
		1.9	Grinding PCD and PCBN 72-73
		1.10	Hand grinding 74
		1.11	Metallography 75
		2	GLASS INDUSTRY 76-91
		2.1	Decorative glass grinding 79-85
		2.2	Grinding, cutting and drilling of flat glass 86-88
		2.3	Laboratory glass grinding and drilling 89-91
		3	CONSTRUCTION AND STONE-CUTTING 92-101
		3.1	Cutting 94-96
		3.2	Cutting out 97
		3.3	Grinding 98
		3.4	Profile grinding 99
		3.5	Manual cutting-off and grinding 100-101
		4	COMPOSITE MATERIAL GRINDING 102-104



SWATYCOMET was founded in 2010 and represents the merger of two reputable companies with their own individual rich traditions, i.e. over 130 years of SWATY in Maribor and over 50 years of COMET in Zreče.

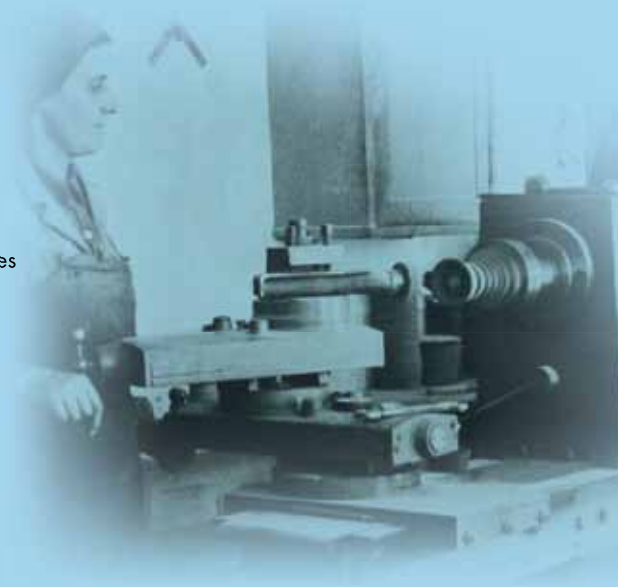

Grinding belongs among those cutting procedures in which the tool has many cutting edges that are irregular in shape and act as turning knives during grinding. Grinding is performed at very high speeds, up to 100m/s.

It can be divided into coarse, fine, honing and finishing. The following effects can be achieved:

- High material stock removal rates
- High dimensional accuracy
- Very smooth surfaces
- Ability to grind very hard materials

The main motion involved is tool rotation.

With regard to the type and feed of the workpiece and tool motion, grinding is divided into:

- Cylindrical grinding
- Surface grinding
- Profile grinding
- Tool sharpening

Grinding tools are bonded abrasives. The quality and applicability of an abrasive depend on the quality and the specification ratios of the abrasive grit, the bonding material and the pores. The specification of an abrasive is determined by:

- Abrasive grit quality
- Abrasive grit size
- Hardness
- Structure
- Bonding material



Resin bonded grinding wheels



Vitrified bonded grinding wheels



Hybrid bonded grinding wheels



Metal bonded grinding wheels









Electroplated grinding wheels



Vacuum brazed grinding wheels



BONDING SYSTEMS		PROPERTIES	USE
	Resin bonded	Organic, partially elastic bond	Smaller removal and sharpening of metal materials
	Vitrified bonded	Rigid, brittle bond	Greater removal of hard, tough metal materials
	Hybrid bonded	Hard, partially brittle bond	Great removal of hard metal materials on CNC machines
	Metal bonded	Hard, tough bond	Processing glass, technical and grinding ceramics, stone and concrete
	Electroplated	Rigid single-layer distribution of abrasive	Processing of metal and non-metal materials
	Vacuum brazed	Rigid single-layer distribution of abrasive	Coarse processing of non-metal materials

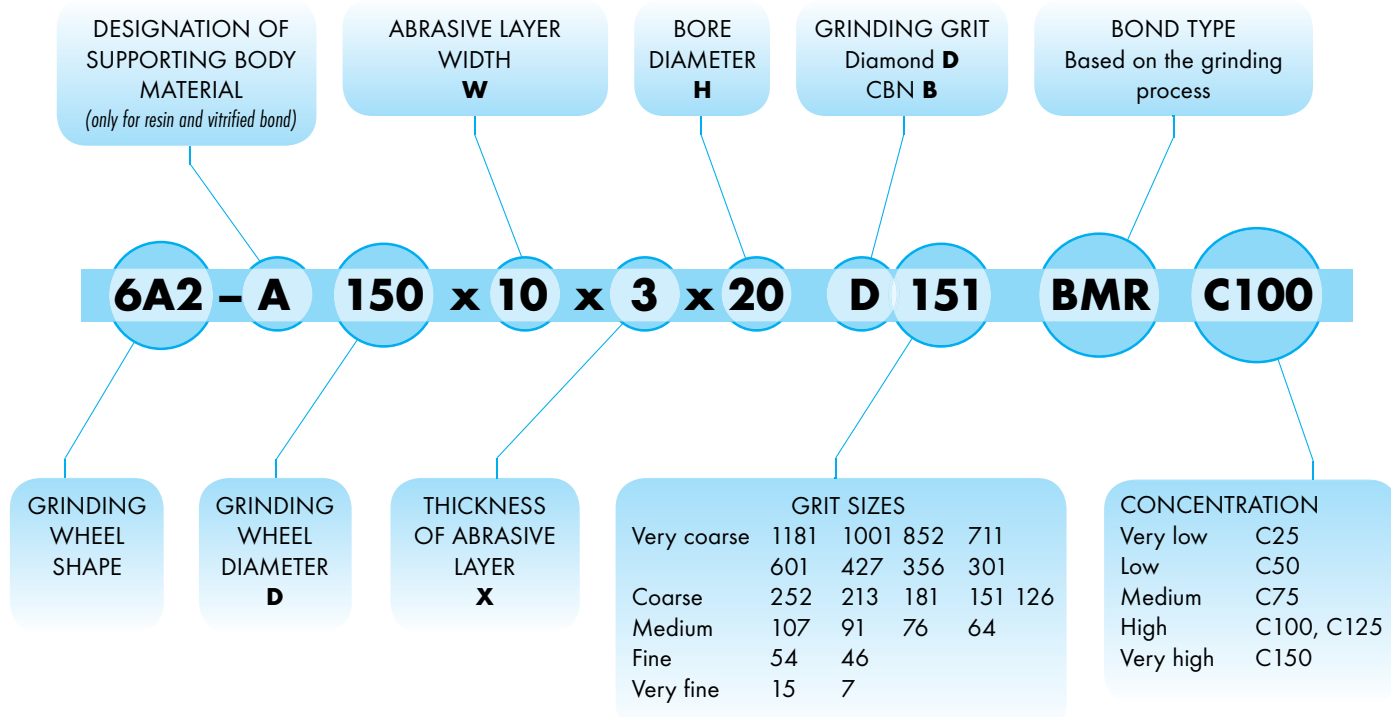
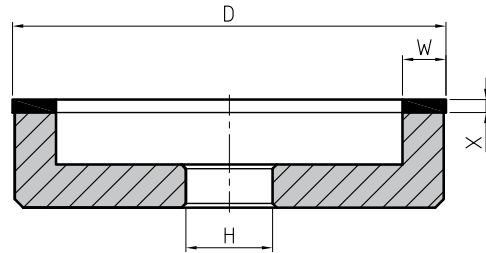

Necessary data for ordering:

- shape (plan for non-standard shapes)
- type of body (special requirements)
- dimensions
- abrasive type (special requirements)
- intended use of grinding wheel.

When re-ordering the order can be carried out only with an identical grinding wheel.

STANDARD SHAPES OF GRINDING TOOLS



Tool shapes are standardized, but they can also be custom-made according to the needs of the users.

6 Shape of the body	A Cross-section of the abrasive layer	2 Location of the abrasive layer	C Modification/alternative
	 A AH B		
	 C CH		
	 D DD		
	 E EE		
	 F FF		
	 G H		
	 J K		
	 L LL		
	 M P Q QQ		
	 S U V Y		



The body material is adapted to the shape and properties of the grinding tool bond. Therefore, it is selected by the manufacturer.

Usually the following materials are used:

Material	DESIGNATION	VIBRATION DAMPING	HEAT TRANSFER ABILITY	MECHANICAL STRENGTH
SINTER-ALUMINIUM	/	■ ■ ■	■ ■ ■	■ ■ ■
DURALUMINIUM	A	■ ■	■ ■ ■ ■	■ ■ ■ ■
BAKELITE	B	■ ■ ■ ■ ■	■	■ ■
STEEL	J	■	■ ■ ■ ■	■ ■ ■ ■ ■
ABRASIVE SINTER	N	■ ■ ■	■ ■ ■	■ ■ ■
CERAMICS	K	■	■ ■	■ ■

Less pronounced property ■
Well pronounced property ■ ■ ■

SINTER-ALUMINIUM is used for more rigid supporting bodies in softer bond systems. It adequately dampens vibrations, transfers heat and provides good mechanical strength. It is a medium-weight material.

DURALUMINIUM is used when a more stable supporting body is needed. The supporting body material provides good mechanical strength and a better heat transfer than sinter-aluminium. It is one of the heavier materials.

BAKELITE is a lighter material with very good vibration dampening properties. It is suitable primarily for wide resin bonded abrasive rings that are used for surface or external circular grinding (e.g. for the 1A1 shape).

STEEL – steel supporting bodies are significantly heavier than the other four types of materials. They are used whenever good mechanical properties need to be ensured for thin abrasives, for example cutting tools (1A1R).

ABRASIVE SINTER – has the same mechanical properties as sinter-aluminium. It is primarily suitable for the simple use of resin bonded grinding wheels. It represents a suitable choice when the abrasive ring is planned to be used completely. It is available only after prior consultation with the manufacturer of grinding wheel.

CERAMICS are only used for vitrified bonded grinding wheels. They are rigid and hard, but allow full use of the abrasive ring.



Various types of superabrasive grits are used in grinding tools.

As the hardest abrasive material, diamond is suitable for grinding and processing of non-ferrous metals:

- tungsten carbides,
- combinations of tungsten carbides with steel,
- cermet,
- PCD in PCBN,
- all types of ceramics,
- glass,
- stone,
- construction materials,
- composites,
- ...

CBN (cubic boron nitride) is the second hardest abrasive material used for working:

- all types of steel,
- stellite.

Compared to classic abrasives, superabrasive grits have excellent mechanical properties. However, they have less thermal stability, therefore they need to be cooled during grinding.

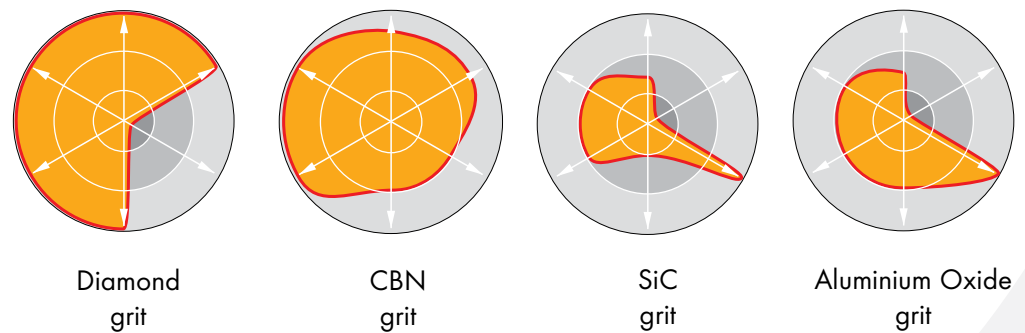
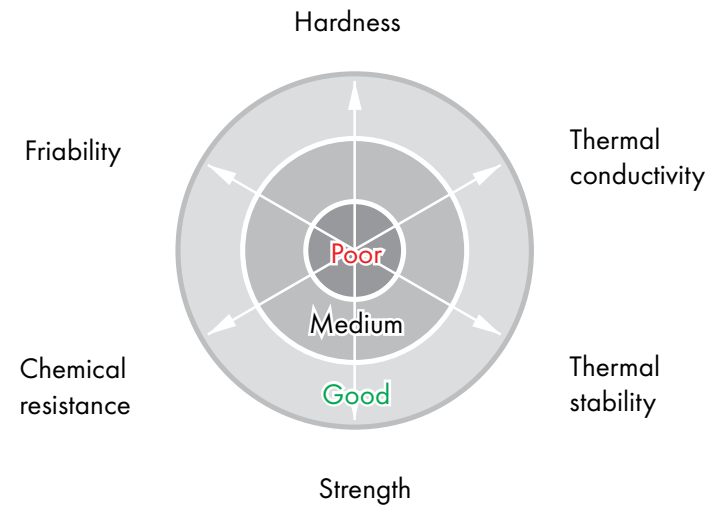



The size of the abrasive grits determines the effect of grinding and the quality of the grinding surface.

The most cost-effective choice is the coarsest granulation that still achieves the required surface finish.

If a greater amount of material needs to be removed during grinding, a combination of coarse grinding and finish grinding is recommended.

For **precise grinding and polishing**, the following table applies which shows the granulations according to the different standards determining the abrasive grit size. To simplify, one can view the sizes according to the FEPA standard as approximately corresponding to the mean grit size in microns (D126 is approx. 0.126mm).

	FEPA	ASTM-E-11	DIN 848
Coarse grinding	213	70/80	212/180
	181	80/100	180/150
	151	100/120	150/125
	126	120/140	125/106
Medium fine grinding	107	140/170	106/90
	91	170/200	90/75
	76	200/230	75/63
Fine grinding	64	230/270	63/53
	54	270/325	53/45
	46	325/400	45/38

	DESIGNATION	D35	D25	D15	D7
POLISHING Micron sizes	Size in μm	28-40	16-34	10-20	5-10



The shape and material of the workpiece, the method of grinding and the machine for grinding determine the quality of the grinding wheels. The abrasive grit size is chosen based on the desired depth of grinding and the required surface quality.

The roughness of the ground workpiece surface is measured primarily in the precision grinding of the metal materials, subject to:

GRINDING METHOD	GRIT SIZE according to the FEPA		Medium roughness deviation Ra (micron)	Surface quality N
	Diamond	CBN		
Very coarse grinding	/	B213	1.32	N7
	/	B181	1.12	N7 - N6
	/	B151	0.75	N6
	D213	B126	0.66	N6
	D181	B107	0.53	N6 - N5
	D151	B91	0.50	N6 - N5
	D126	B76	0.45	N6 - N5
	D107	B64	0.40	N5
Medium fine grinding	D91	B54	0.33	N5 - N4
	D76	B46	0.25	N5 - N4
	D64	B35	0.18	N4
	D54	/	0.16	N4 - N3
	D46	/	0.15	N4 - N3
Polishing	Micron sizes	/	/	N3 - N2



The bond type selection is based on the properties of the workpiece and the grinding process. In general, softer materials are treated with coarser grinding wheels and harder workpieces with softer ones.

The hardness of the grinding wheel is also dependent on the concentration of the superabrasive grits - the higher it is, the harder the grinding wheel.

	SOFTER BONDS	HARDER BONDS
Cutting capacity	Greater	Smaller
Relative stock removal	Greater	Smaller
Pressure/force on spindle	Smaller	Greater
G grinding factor	Smaller	Greater
Lifespan of grinding wheel	Shorter	Longer
Temperature on the contact surface	Lower	Higher



Resin bond
METALWORKING INDUSTRY

			Various types of steel		Tungsten carbides (WIDIA)	Steel and tungsten carbide	Technical ceramics	Stellite
			Tool	High-speed				
Peripheral surface grinding and external cylindrical grinding	Harder	Wet		V80	BMRT	V80	BMR/B40SR	
	Standard	Wet	BMR	BMRT	BMR	BM3N		
		Dry	BMR	BMRT	B40SR			
Softer grinding	Wet/soft	BM75	BMN	B40SN				
Internal cylindrical grinding	Standard	Wet	BMK		V80	BMK		
	Harder	Wet	CXB	CXB	B245		BMR/B40SR	
Surface grinding on the face	Standard	Wet	BMR	BMRT	BMR			
		Dry	BM75	BMN	B40S			
Tool grinding and sharpening for the metal industry	Standard	Wet		BMRT	BMR			
		Dry	B47SR/BME	B47SR	B40SR			BMR/V80T
Tool grinding and sharpening for the wood programme	Standard	Wet		BP2	BP2			
		Dry		BMR	B40SR			
Profile grinding	Standard	Wet	V80T	CXB	CX100			
CNC tool grinding	Creep feed grinding	Wet		PIMR	HYB			
	Edge sharpening	Wet		PIMR	HYB	CX100		
Cutting	Standard	Wet	BM1R	BM1R	BM1EG/V80T			
		Dry	BM1R	BM1R	BM1EG			
	Thin cutting	Wet	PIMR	PIMR	BMRG			
Polishing	Standard	Wet			BR			

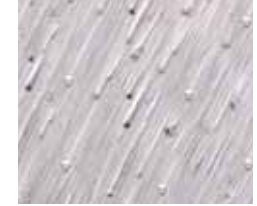

Vitrified bond
METALWORKING INDUSTRY

			Various types of steel		Tungsten carbides (WIDIA)	Grinding PKD
			Hardened steel (low alloy up to 60Hrc)	Hardened steel (over 62Hrc), matrix, OCR		
Peripheral surface grinding and external cylindrical grinding	Harder	Wet	B126 P4V3 C100	B107 P3V3 C100	D181 P3V C100 COARSE	D46 P3V C125 COARSE
	Standard	Wet	B126 O6V3 C100	B126 O5V3 C100	D107 P4V C100 MEDIUM	D25 P3V C125 FINE
		Wet			D64 P4V C100 FINE	
	Softer grinding	Wet	B126 M6V3 C100			
Internal cylindrical grinding - plugs	Standard	Wet	B126 K6V3 C100			
	Harder	Wet	B126 M6V3 C100	B107 O5V3 C100	D46 P4V C100	
Surface grinding on the face	Standard	Wet			D64 P4V C100	

Metal bond
GLASS INDUSTRY

		Glass
Surface grinding and drilling	Basic	MB 16
	Harder	MB 01
Manual grinding and cutting	Basic	MB 02
	Harder	MB 01
CNC grinding	Harder	MB 17

SUPERABRASIVE GRIT CONCENTRATION





The concentration should be selected with respect to the grinding procedure. Low concentrations are recommended for fine abrasive grits, large contact surfaces between the abrasive and workpiece and in manual grinding; high concentrations are more suitable for coarse grits, small contact surfaces and whenever large profile stability of the grinding tool is required.

This is expressed as the quantity of diamond or cubic boron nitride grits in carats/cm³ of the abrasive layer (1ct=0.2g).

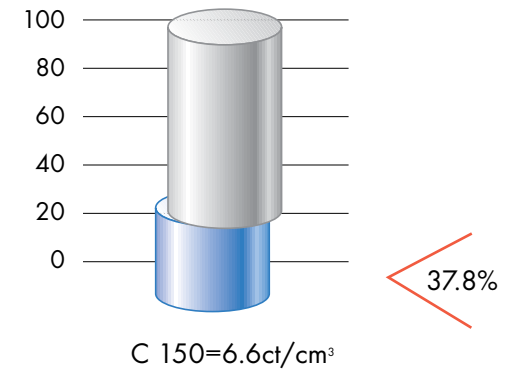
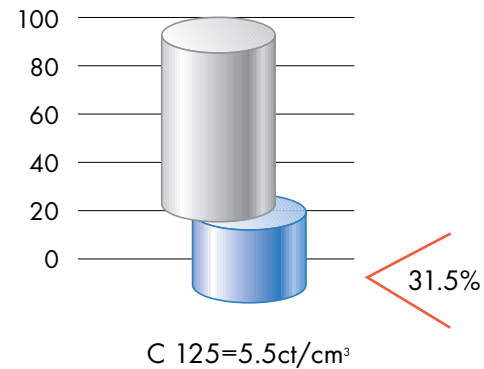
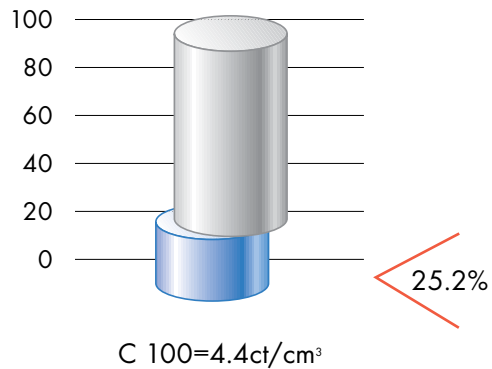
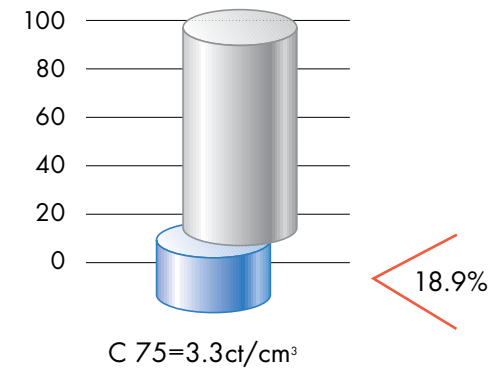
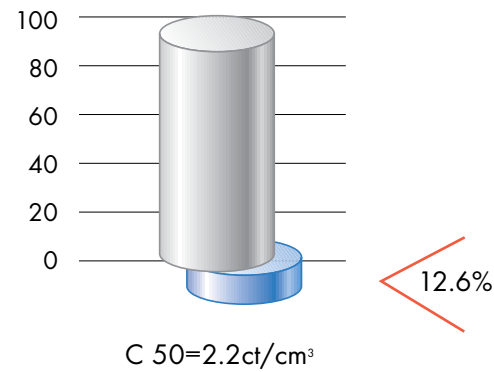
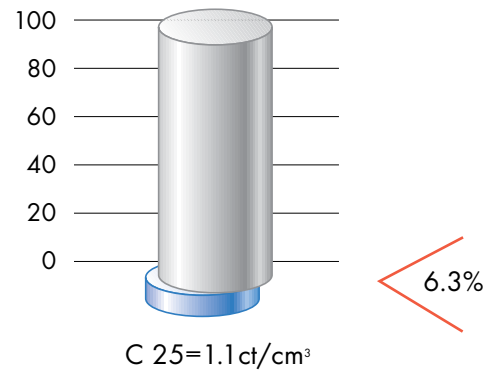
The diagrams show the volume percentage of superabrasive grits in the abrasive ring.



Bonding system 
Superabrasive grits 









INSTRUCTIONS FOR THE SAFE USE OF GRINDING TOOLS



All superabrasive tools are manufactured in accordance with EN 13236 and OSA provisions which determine the safety requirements for their production and use.

Therefore, products usually indicate the following (when possible):

- EN 13236,
- OSA,
- maximum peripheral speed,
- maximum revolutions (min^{-1}),
- short designation or symbol for limited use.

Short designation	Designation	Application	Symbols
RE 1	Free-hand grinding NOT allowed	The grinding tool is only used on stationary grinding machines. Note: This restriction only applies to grinding tools which are not used on hand-held machines, but can be installed on such machines.	 
RE 3	Wet grinding NOT allowed	Grinding tool is suitable only for dry grinding.	 
RE 4	Permitted use only on machines with a totally enclosed working area.	The grinding tool is only used on stationary grinding machines with a TOTALLY ENCLOSED WORKING AREA .	/
RE 6	Side pressure is NOT allowed	The grinding tool is only used on cutting machines. Note: This restriction only applies to grinding tools which are used on hand-held machines.	 
RE 10	Only wet grinding is allowed	The grinding tool is only suitable for wet grinding.	 

The following subjects are responsible for safety during grinding:

Grinding tool manufacturer

The grinding tool manufacturer must manufacture a safe tool, which is achieved through the correct selection of raw materials, a correct technological manufacturing procedure and the required product control.

The control methods are prescribed by the SIST EN 13236 and the FEPA international standards as well as our internal standards. The dimensional requirements are defined by ISO 22917.

Machine manufacturer

The grinding machine manufacturer must ensure a stable machine installation and the strength of the protective housings. The strokes and displacements must be set so that the required product accuracy can be achieved. Instructions for the correct and safe use of the machine must also be prepared.

Machine/tool user

Follow the manufacturer's instructions for the machine and the tool:

- Take care to store the grinding tools properly.
- Check the grinding tool before mounting (in case of damage, contact the grinding tool manufacturer).
- If necessary, balance and properly mount the grinding tool.
- Prepare the grinding machine correctly.
- Test the grinding tool without any load.

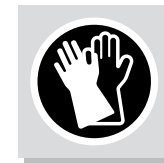
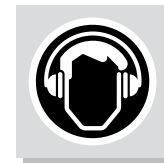
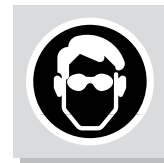
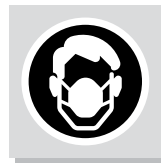



The machine/tool user should consider the following:

Mounting the grinding tools

High-quality grinding requires grinding machines with a rigid construction, a powerful drive and high-quality spindle bearings. During mounting, it is recommended that the grinding tool is first partially tightened and that the run out is minimized using a measuring device. All contact surfaces must be clean. Once mounted, the grinding tools should not be removed from the spindle until they are worn out.

Cooling

Cooling should be performed whenever the grinding procedure allows for it, since the coolant takes away the heat and the chips and enables a finer surface finish to the workpiece. We recommend the use of a water solution with up to 2% oil, and oil with additives.

The use of water solutions with additives is not recommended during grinding with resin bonded CBN grits due to the risk of chemical degradation of the abrasive.

Feeding the coolant at the contact area is significantly better than feeding it to the grinding tool core or workpiece.

Dressing grinding tools and opening the structure

Vitrified bonded grinding tools are used for dressing. Their grit size must be one grade coarser than that of the superabrasive grits which are dressed. Both grinding tools here revolve in the same direction, whereby the peripheral speed of the vitrified bonded grinding tool is 15-25m/s, and that of the superabrasive grinding tool is lower by half. Grinding tools with abrasive rings on the face can also be dressed by rubbing them against abrasive grits, which are applied onto a flat metal or glass surface.

This reopens the surface of a dulled grinding tool, even though the grinding tools are already self-sharpening when correctly used.

The structure of dulled grinding tools can also be opened using a vitrified bonded tool, which is enclosed with the grinding tool (only for resin and hybrid bonded tools). Resin bonded CBN grinding tools for flat surface grinding hardened steels are sometimes also dressed by grinding into soft steels at a peripheral speed of 15m/s.

Dressing and profiling of vitrified bonded superabrasive grinding tools is also possible with diamond systems.



Storage of grinding tools

Grinding tools are sensitive to atmospheric influences and impacts which cause cracks that are invisible to the human eye but may cause the tool to break when the machine is started. Grinding tools must be stored well-protected, preferably in the original packaging. The storage area should not be damp and the temperature not below freezing.

The lifespan of resin and hybrid bonded grinding wheels is three years from the date of manufacture. Vitrified, metal and electroplated grinding wheels do not have limited durability if stored properly.

All grinding wheels have a 3-year warranty.

Inspection of grinding tools

Even though the packaging protects the product during transport, the boxes or crates should be moved carefully. After admission to the warehouse and prior to mounting the grinding wheel on the grinding machine, be sure to make a visual inspection.

If the grinding wheel is inadequate, consult the manufacturer about its suitability for use prior to mounting.

1

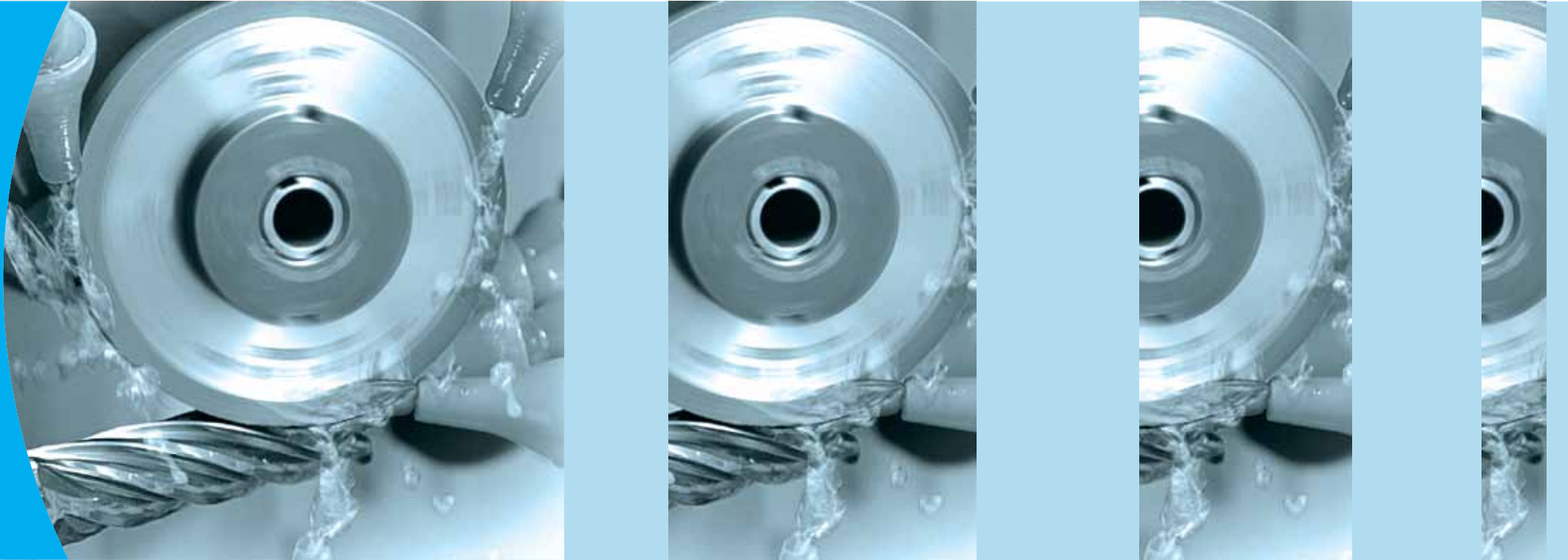

OVERVIEW OF ABRASIVES BY THEIR INTENDED USE



		1.1 Peripheral surface grinding and external cylindrical grinding	28-33
		1.2 Internal cylindrical grinding	34-40
		1.3 Surface grinding on the face	41-45
		1.4 Tool grinding and sharpening	46-58
		1.5 Tool grinding and sharpening in the wood industry	59-63
		1.6 Profile grinding	64-65
		1.7 CNC tool grinding	66-68
		1.8 Cutting	69-71
		1.9 Grinding of PCD and PCBN	72-73
		1.10 Manual grinding	74
		1.11 Metallography	75

STANDARD SHAPES OF GRINDING TOOLS IN THE METALWORKING INDUSTRY

1A1 - 28, 29, 34, 67

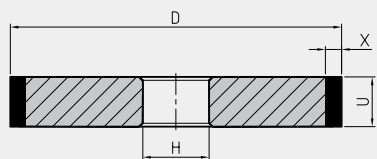

1A1-K - 35

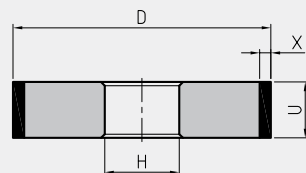

1A1R - 69

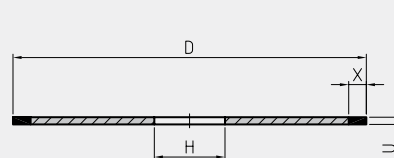

1A1R-O - 70

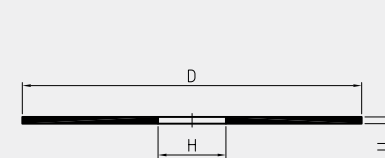

1A1S - 36

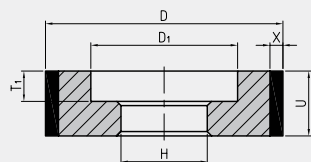

1A1W - 37, 39

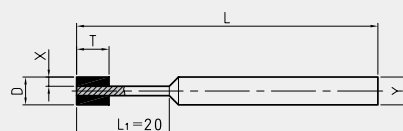

1A2M - 42

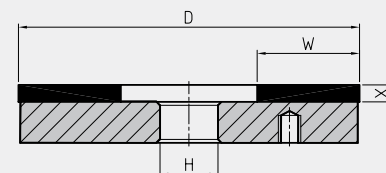

1A8 - 40

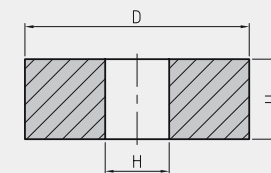

1A8S - 40

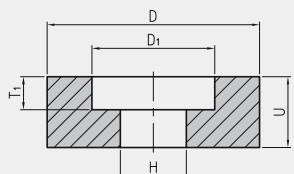

1A8W - 38

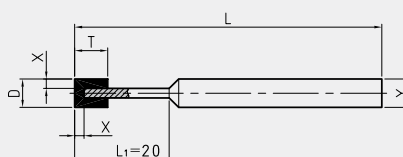

1C9 - 47

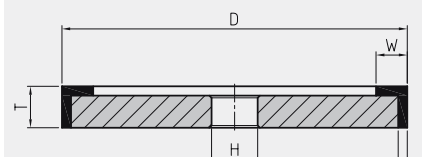

1F1R - 71

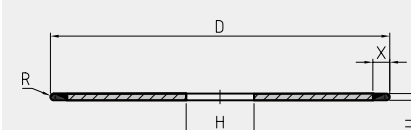

1FF1 - 47

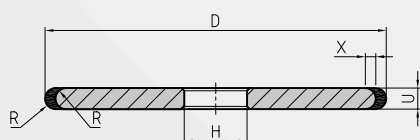

1L1 - 46

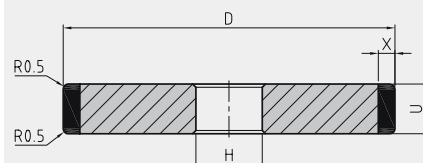

1M2 - 42

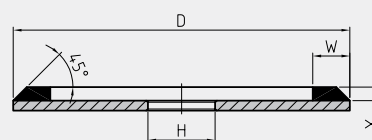

1SM - 62

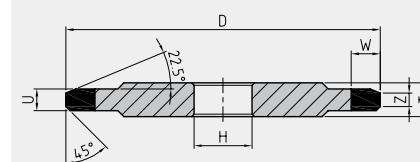

1V1/V° - 46, 67

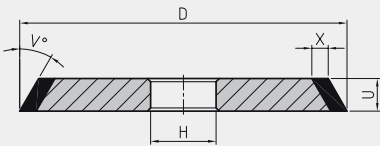

3A1 - 30, 31

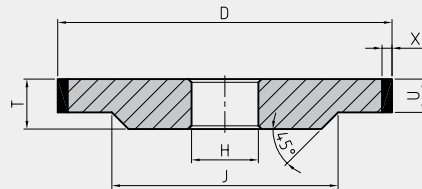

3F1 - 64

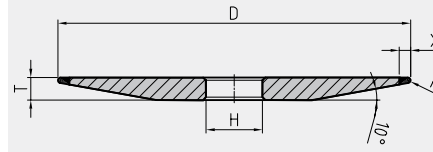

4A2 - 48

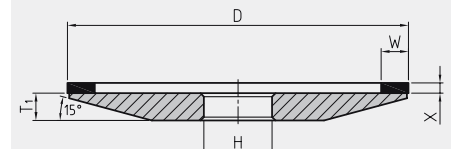

4C2R - 64

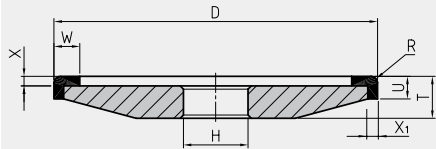

4BT9 - 49

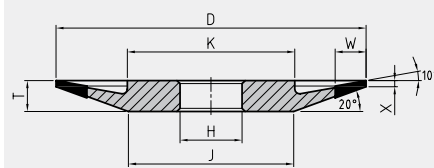

4ET9 - 49

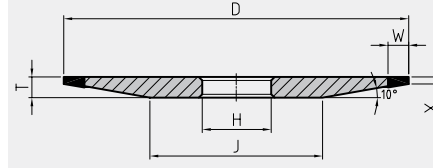

6A2 - 45, 72

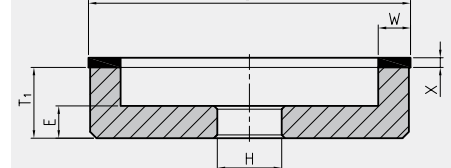

6A2-DVU - 61

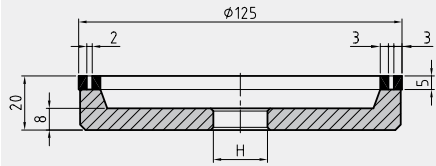

6A2G - 63

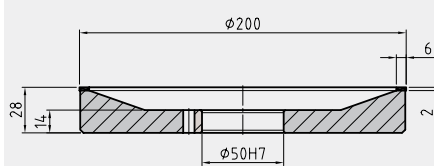

6A2-TR - 60

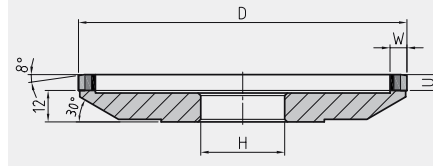

6A9 - 50

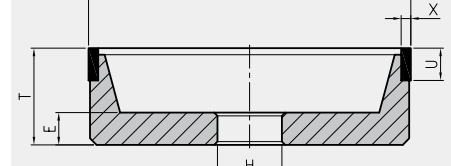

6C2 - 50

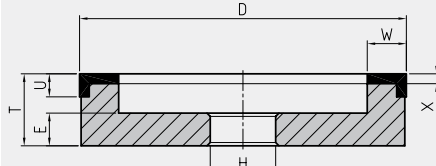

6V9 - 51

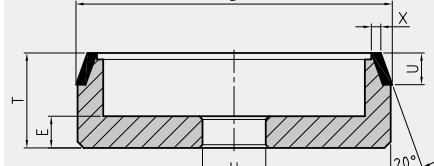

9A3 - 52

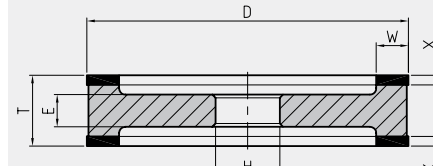

9U1 - 52

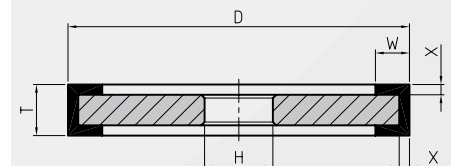

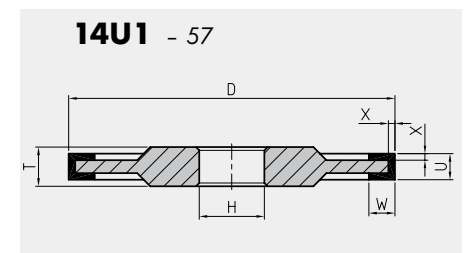
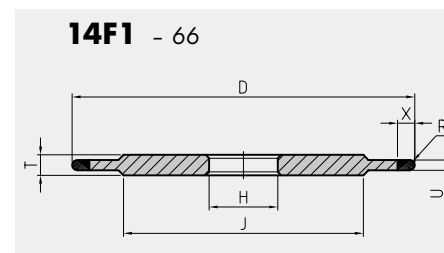
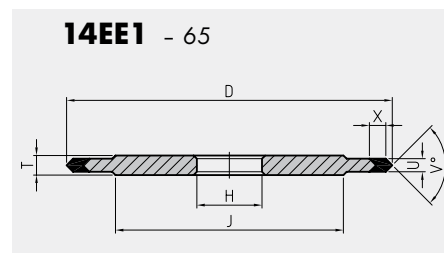
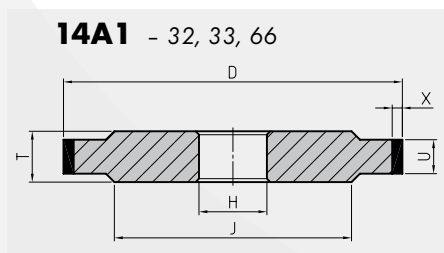
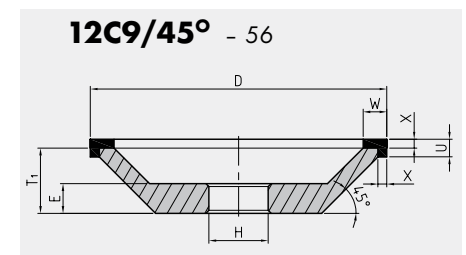
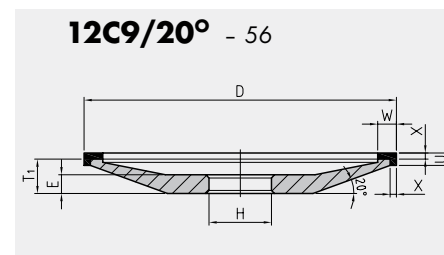
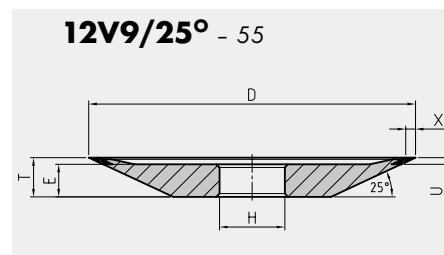
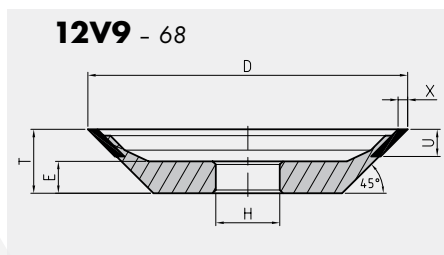
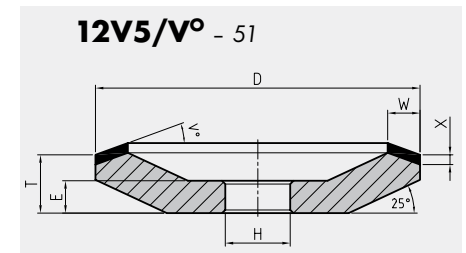
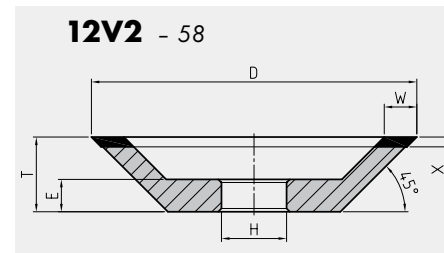
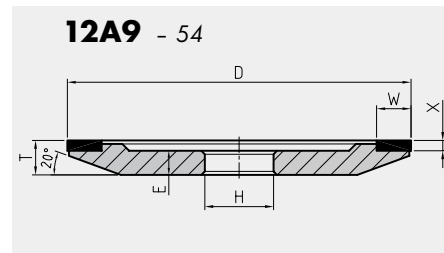
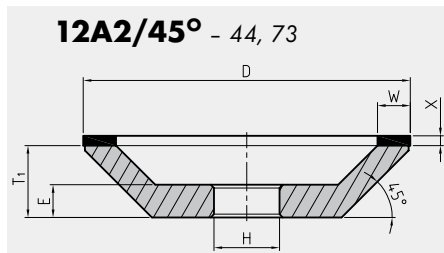
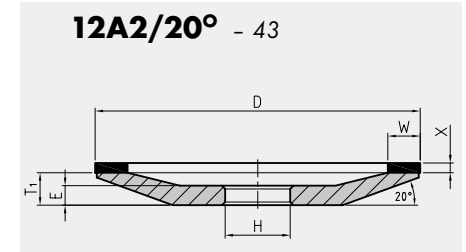
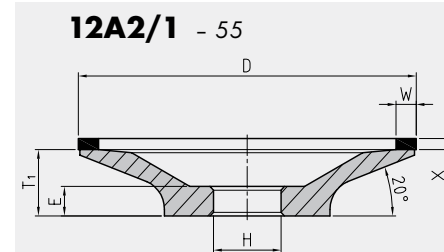
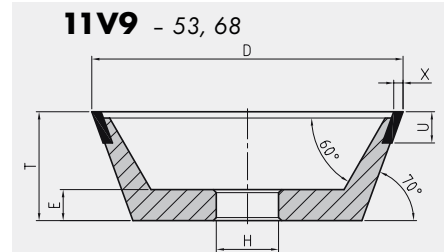
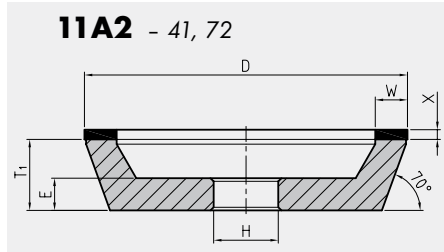

15V9/Vz° - 58

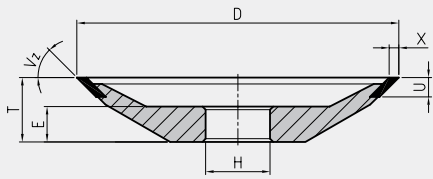

RP - 74

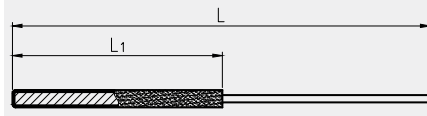

US - 1A1W - 62

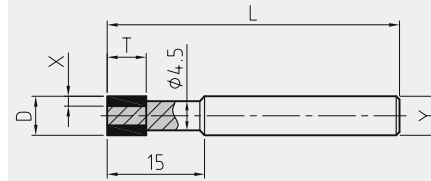

VB - 4B9 - 59

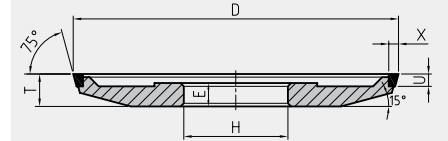

VB - 6A2DV - 60

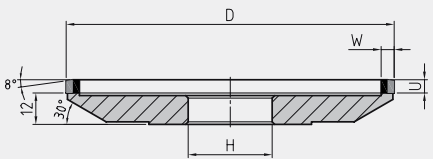

VB - 12B9 - 63

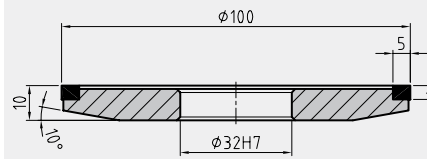

VD - 4B9 - 61

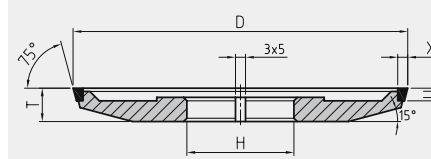

VD - 6A2DV - 59

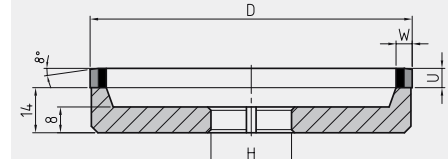

VD - 12A1 - 62

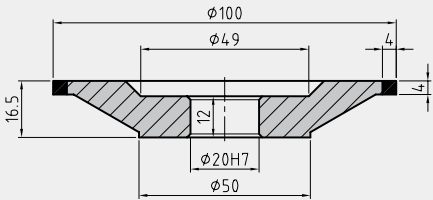

VD - 12B9 - 63

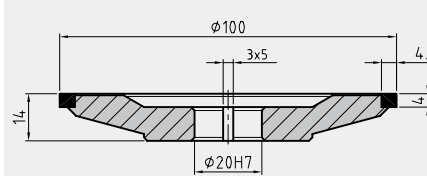



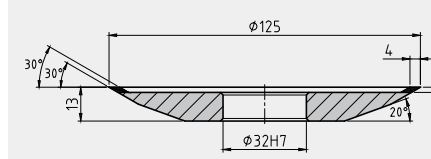

4V2 - 63



RECOMMENDATIONS FOR THE SELECTION OF THE WORKING PARAMETERS FOR STANDARD MACHINES

The table below shows the guidelines for precision grinding in the metalworking industry with respect to the grinding process.

		SPEED OF THE LONGITUDINAL FEED m/min	GRINDING DEPTH		
			Coarse grinding mm	Medium grinding mm	Fine grinding mm
Surface grinding		5-20	0.01-0.03	0.005-0.02	0.001-0.01
External cylindrical grinding		0.5-3.0	0.01-0.02	0.005-0.01	0.001-0.005
Internal cylindrical grinding		0.5-2.0	0.005-0.02	0.005-0.01	0.001-0.005
Grinding and tool sharpening		0.5-6.0	0.02-0.01	0.01-0.02	0.005-0.001

Grinding phases for the production of milling machines	PERIPHERAL SPEED V_s m/s		FEED RATE mm/min		GRINDING DEPTH mm	
	D	CBN	D	CBN	D	CBN
Creep feed grinding	18-22	30-50	30-200	50-200	Full groove depth up to ~ 7mm	Full groove depth up to ~ 7mm
Grinding of free angle	18-22	30-50	50-300	200-300	0.3-1	0.3-1.5
Lateral grinding	18-22	30-50	30-40	60-70	Depends on the geometry of the front part	Depends on the geometry of the front part
Lateral grinding - slits	18-22	30-50	30 - 70	40 - 50	Full groove depth up to ~ 4mm	Full groove depth up to ~ 5mm

Refer to the manufacturer for all other methods.

WORKING PARAMETERS FOR CREEP FEED GRINDING IN THE MANUFACTURE OF TUNGSTEN CARBIDE CUTTING TOOLS



PROFESSIONAL
Polyamide resin bond

HYPERFLUTE
Hybrid bond

min. max.

Grinding depth (mm)	Feeding speed Vt (mm/min)											
	30	40	50	60	70	80	100	120	140	160	180	200
2.6				2.6	3.0				6.1	6.9	7.8	8.7
2.8				2.8	3.3				6.5	7.5	8.4	9.3
3.0				3.0	3.5			6.0	7.0	8.0	9.0	
3.2			2.7	3.2				6.4	7.5	8.5	9.6	
3.4			2.8	3.4				6.8	7.9	9.1	10.2	
3.6			3.0				6.0	7.2	8.4	9.6		
3.8		2.5	3.1				6.3	7.6	8.9	10.1		
4.0		2.7	3.3				6.7	8.0	9.3	10.7		
4.2		2.8	3.5			5.6	7.0	8.4	9.8			
4.4		2.9				5.9	7.3	8.8	10.3			
4.6	2.3	3.1			5.4	6.1	7.7	9.2				
4.8	2.4	3.2			5.6	6.4	8.0	9.6				
5.0	2.5	3.3			5.8	6.7	8.3	10.0				
5.5	2.8			5.5	6.4	7.3	9.2	11.0				
6.0	3.0			6.0	7.0	8.0	10.0					
6.5	3.3		5.4	6.5	7.6	8.7	10.8					
7.0			5.8	7.0	8.2	9.3						

Grinding tool peripheral speed Vc:
Professional=18-22m/s
NEW - Hyperflute=18m/s

Formulas:
 $Q'w = (at \cdot Vt) / 60$ [mm³/mm*s]
 $Vt = (Q'w \cdot 60) / at$ [mm/min]

Quantity of ground material Q'w [mm³/mm*s]
Grinding depth at [mm]
Feeding speed Vt [mm/min]

1.1

PERIPHERAL SURFACE GRINDING AND EXTERNAL CYLINDRICAL GRINDING



Resin bonded grinding wheels

1A1

D x U x X x H

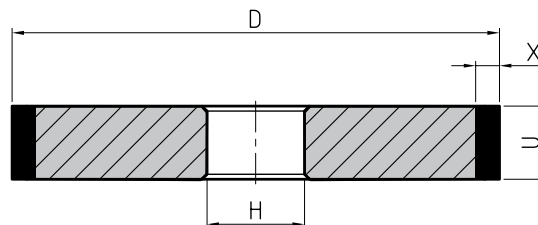

D	U	X	H
75	5-20	3/4/5/6	Custom-made
90	5-20	3/4/5/6	
100	5-20	3/4/5/6/8	
125	5-20	3/4/5/6/8	
150	5-20	3/4/5/6/8/10	
175	5-25	3/4/5/6/8/10	
200	10-25	3/4/5/6/8/10/12	
220	10-25	3/4/5/6/10	
250	10-25	3/4/5/6/8/10/12/15	
300	10-30	3/5/6.4/8/10/12.7	
350	12-30	3/5/8/10/15	
400	12-30	3/5/6.4/12.5	
450	10-30	3/5/10/12.7	
500	15-40	3/6.4/10/12.7	
600	15-40	6.4	
750	15-40	6	

Order printout sample:
 1A1 450 x 20 x 5 x 127
 B151 BMR C75

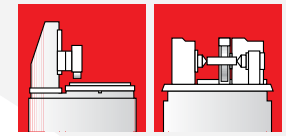

Vitrified bonded grinding wheels

1A1

D x U x X x H

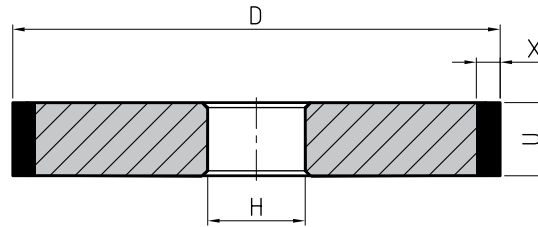

D	U	X	H
100	5-25	6/6.4/8/10/12/12.5/15	20/25/32
125	5-25	6/6.4/8/10/12/12.5/15	20/25/32
150	5-25	6/6.4/8/10/12/12.5/15	20/25/32
175	2-25	6/6.4/8/10/15/20/25	20/25/32/40
200	5-30	6/8/10/12/12.5/15/20/25	20/25/32/40/51
220	5-25	6/10	20/25/32/40/51
250	10-30	6/8/10/12/15	25/32/40/51/76
300	10-25	8/10/12	32/40/51/76/127

1A1-K

D x U x X x H

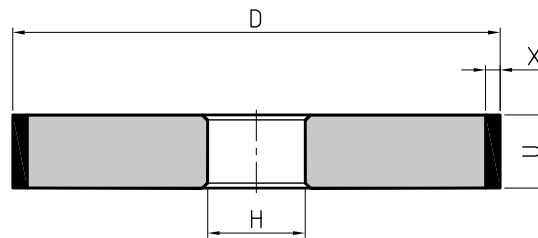

D	U	X	H
250	10-30	5/6/8/10/12/15	25/32/40/51/76
300	10-25	5/6/6.4/8/10/12	32/40/51/76/127
350	10-25	5/8/10/15/25	32/40/51/76/127/151
400	10-25	5/6.4/10/12.5/20	51/76/127/151/203
450	10-25	5/10/12.5/20	76/127/151/203
500	10-25	6.4/10	76/127/151/203

Order printout sample:
 1A1-K 400 x 20 x 5 x 127
 B126 O6V3 C100

PERIPHERAL SURFACE GRINDING AND EXTERNAL CYLINDRICAL GRINDING



Resin bonded grinding wheels

3A1

D x U x X x H

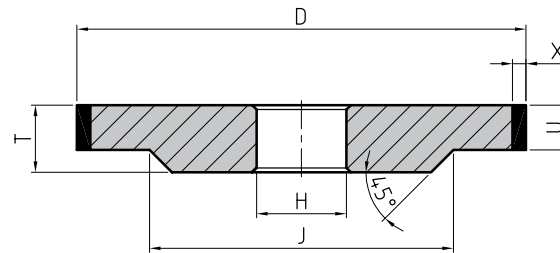

D	U	X	H	T _{min}	J
50	3/5/8	3/4/5	Custom-made	5	35
55	3/5/8	3/5		5	38
63	3/5/8	3/5		5	45
75	5/6/8/10	3/4/5/6		8	55
90	5/6/8/10	3/4/5/6		8	65
100	5/6/8/10	3/4/5/6/8		8	75
125	5/6/8/10/12	3/4/5/6/8		10	100
150	6/8/10/12/15/20	3/4/5/6/8/10		10	120
175	6/8/10/12/15/20/25	3/4/5/6/8/10		10	140
200	6/8/10/12/15/20/25	3/4/5/6/8/10/12		12	160
220	6/8/10/12/15/20/25	3/4/5/6/10		12	180
250	8/10/12/15/25/30	3/4/5/6/8/10/12/15		12	200
300	10/15/20/25/30	3/5/6.4/8/10/12.7		15	250
350	10/15/20/25/30	3/5/8/10/15		15	300
400	10/15/20/25/30	3/5/6.4/12.5		20	350
450	10/15/20/25/30	3/5/10/12.7		20	400
500	15/20/25/30/40	3/6.4/10/12.7		25	450
600	15/20/25/30/40	6.4		25	550
750	15/20/25/30/40	6		25	700

Order printout sample:
 1V3A1 250 x 10 x 3 x 76
 D126 B40S C75

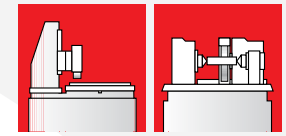

Vitrified bonded grinding wheels

3A1

D x U x X x H

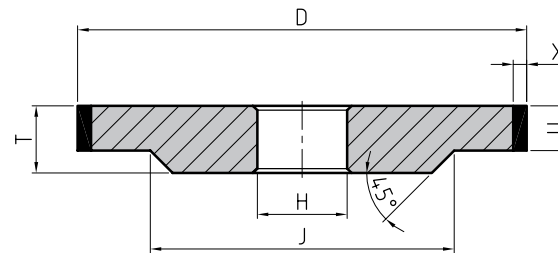

D	U	X	H	T	J
100	5-25	6/6.4/8/10/12/12.5/15	Custom-made	Custom-made	Custom-made
125	5-25	6/6.4/8/10/12/12.5/15			
150	5-25	6/6.4/8/10/12/12.5/15			
175	5-25	6/6.4/8/10/15/20/25			
200	5-25	6/8/10/12/12.5/15/20/25			
220	5-25	5/6/10			
250	10-25	6/8/10/12/15			
300	10-25	6/6.4/8/10/12			

Order printout sample:
 3A1 250 x 15 x 8 x 76
 B126 O6V3 C100

PERIPHERAL SURFACE GRINDING AND EXTERNAL CYLINDRICAL GRINDING

Resin bonded grinding wheels

14A1

D x U x X x H

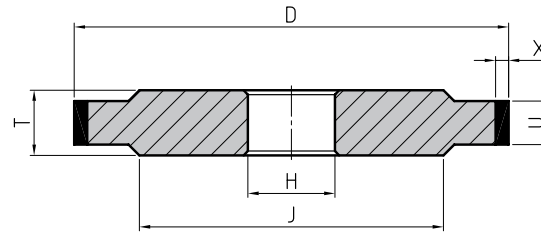

D	U	X	H	T _{min}	J
50	3/5/8	3/4/5	Custom-made	5	35
55	3/5/8	3/5		5	38
63	3/5/8	3/5		5	45
75	5/6/8/10	3/4/5/6		8	55
90	5/6/8/10	3/4/5/6		8	65
100	5/6/8/10	3/4/5/6/8		8	75
125	5/6/8/10/12	3/4/5/6/8		10	100
150	6/8/10/12/15/20	3/4/5/6/8/10		10	120
175	6/8/10/12/15/20/25	3/4/5/6/8/10		10	140
200	6/8/10/12/15/20/25	3/4/5/6/8/10/12		12	160
220	6/8/10/12/15/20/25	3/4/5/6/10		12	180
250	8/10/12/15/25/30	3/4/5/6/8/10/12/15		12	200
300	10/15/20/25/30	3/5/6.4/8/10/12.7		15	250
350	10/15/20/25/30	3/5/8/10/15		15	300
400	10/15/20/25/30	3/5/6.4/12.5		20	350
450	10/15/20/25/30	3/5/10/12.7		20	400
500	15/20/25/30/40	3/6.4/10/12.7		25	450
600	15/20/25/30/40	6.4		25	550
750	15/20/25/30/40	6		25	700

Order printout sample:
 14A1 500 x 20 x 6.4 x 203.2
 D107 BMR C75

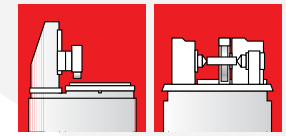

Vitrified bonded grinding wheels

14A1

D x U x X x H

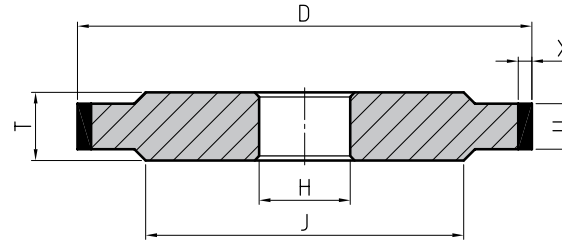

D	U	X	H	T	J
100	5-25	6/6.4/8/10/12/12.5/15	Custom-made	Custom-made	Custom-made
125	5-25	6/6.4/8/10/12/12.5/15			
150	5-25	6/6.4/8/10/12/12.5/15			
175	2-25	6/6.4/8/10/15/20/25			
200	5-30	6/8/10/12/12.5/15/20/25			
220	5-25	5/6/10			
250	10-30	6/8/10/12/15			
300	10-25	6/6.4/8/10/12			

Order printout sample:
 14A1 300 x 25 x 10 x 127
 B 126 P4V3 C100



Resin bonded grinding wheels

1A1

D x U x X x H

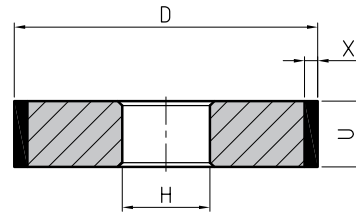

D	U	X	H
6	6-10	1.5	Custom-made
7	6-10	2	
8	6-10	2	
9	6-10	2	
10	5-10	2	
12	5-10	2	
15	10-15	2/3/5	
18	10-15	2	
20	10-15	2/3/5	
22	10-15	2/3/5	
25	10-15	2/3/5	
30	10-20	2/3/5	
35	10-20	2/3/5	
40	10-20	3/4	
45	10-20	3/4	
50	5-20	3/4/5	
55	5-20	3/5	
63	5-20	3/5	

Order printout sample:
 1A1 35 x 12 x 3 x 10
 B107 BMK C75



Vitrified bonded grinding wheels

1A1- K

D x U x X x H

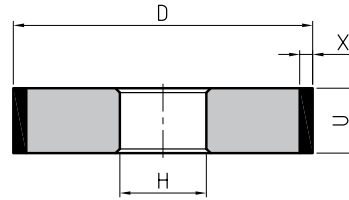

D	U	X	H
20	10-20	3	3/6/8/10
22	8	3	8
25	10-25	3/5	6/8/10/13
30	10-25	3	8/10/13/16/20
35	10-25	3	8/10
40	10-25	3/8	8/10/13/16
45	10-25	7.5	8/10
50	10-25	3	8/10/13/20
60	10-25	3	15
75	10-25	3	20

Electroplated grinding wheels

1A1

D x T x H

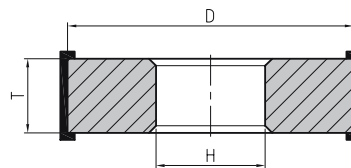

D	T	H
10	10/15	6
15	10	8
20	10	8
25	10	10
30	15	10

Order printout sample:
1A1 20 x 10 x 8
B 126

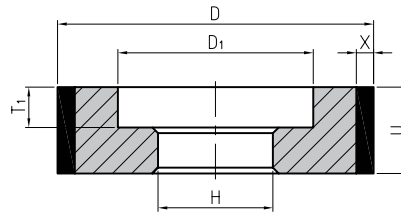
Resin bonded grinding wheels
1A1S
 $D \times U \times X \times H \times D_1 \times T_1$

D	U	X	H	D ₁	T ₁
15	10/15	2/3/4/5	Custom-made	10	4/6
18	10/15	2		12	4/6
20	10/15	2/3/5		12	4/6
22	10/15	2/3/5		12	4/6
25	10/15	2/3/5		13/17	4/6
30	15/20	1.5/2/3/5		16/20	6/8
35	15/20	2/3/5		25	6/8
40	15/20	3/4		30	6/8

Vitrified bonded grinding wheels
1A1S-K
 $D \times U \times X \times H \times D_1 \times T_1$

D	U	X	H	D ₁	T ₁
20	10-20	3	6/8/10	12	max. U/2
22	8	3	8	12	
25	10-25	3/5	6/8/10/12.7/13	13 - 18	
30	10-25	3/5	8/10/12.7/13	16 - 22	
35	10-25	3/5	8/10/12.7/13	20 - 28	
40	10-25	3/5/8	8/10/12.7/13	20 - 32	
45	10-25	7.5	8/10/12.7/13	20 - 28	
50	10-25	3/5	6/8/10/13/20	30 - 40	
60	10-25	3/5	20	30 - 45	
75	10-25	3/5	20	30 - 50	

Order printout sample:

1A1S-K 30 x 20 x 3 x 10 x 15 x 10

B107 O5V3 C100



Resin bonded grinding wheels

1A1W

D x T x X x Y x L

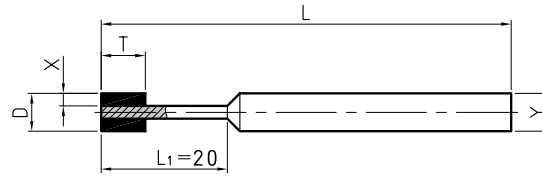

D	T	X	Y	L
6	6/10	1.5	6	70
7	6/10	2	6	70
8	6/10	2	6	70
9	6/10	2	6	70
10	6/10	2	6	70
12	6/10	2	6	70
15	6/10/12	2	6/8	70
18	6/10/12	2	6/8/10	70
20	6/10/12	2	6/8/10	70

Vitrified bonded grinding wheels

1A1W

D x T x X x Y x L

D	T	X	Y	L
8	6/10	2	6	70
9	6/10	2	6	70
10	6/10	2	6	70
12	6/10	2	6	70
14	6/10	2	6	70
15	6/10/12	2	6/8	70
18	6/10/12	2	6/8/10	70
20	6/10/12	2	6/8/10	70

Order printout sample:
1A1W 10 x 6 x 2 x 6 x 70
B91 O5V3 C100

Resin bonded grinding wheels

1A8W

D x T x X x Y x L

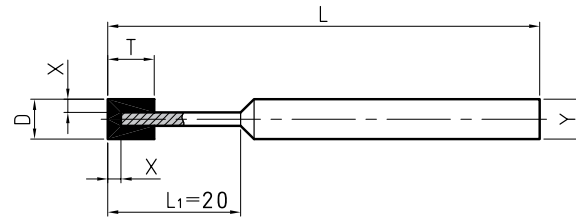

D	T	X	Y	L
3	6	0.5	3/6	70
4	6	1	3/6	70
5	6	1.5	3/6	70
6	6	2	3/6	70

Order printout sample:
 1A8W 6 x 6 x 2 x 6 x 70
 D64 B40S C75



Electroplated grinding wheels

1A1W

D x T x L₁ x Y x L

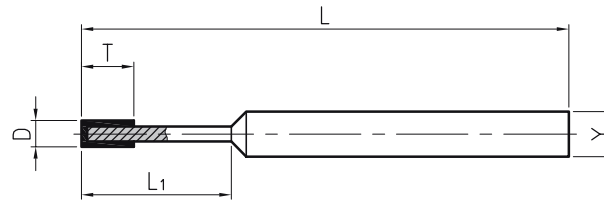

D	T	L ₁	Y	L
1	5	10	3	40/55
1.5	5	12	3	40/55
2	5	12	3	40/55
2.5	5	16	3	40/55
3	5	16	3	40/55

1A1W

D x T x Y x L

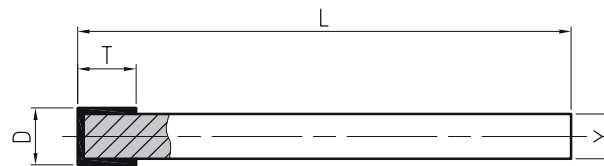

D	T	Y	L
3.5	5	3	40/55
4	5	3	40/55
4.5	5	3	55
5	6	3	55
6	6	3	55
7	8	6	60
8	10	6	80
9	10	6	80
10	10	6	80
12	10	6	80
15	10	8	80

Order printout sample:
1A1W 6 x 6 x 3 x 55
B 126



Vitrified bonded grinding wheels

1A8

D x U x H

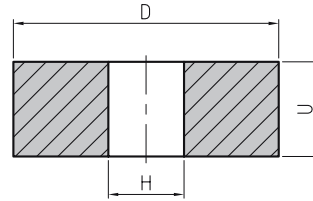

D	U	H
8	5-10	3/4
9	5-10	3/4
10	8-16	3/4
12	8-16	3/4
13	8-16	4/5
14	8-16	4/5/6
16	8-20	4/5/6
17	8-20	4/5/6
18	8-20	4/5/6

1A8S

D x U x H x D₁ x T₁

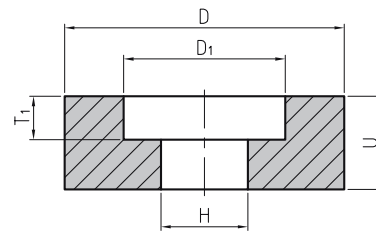

D	U	H	D ₁	T ₁
8	5-10	3/4	Upon arrangement	Max. U/2
9	5-10	3/4		
10	8-16	3/4		
12	8-16	3/4		
13	8-16	4/5		
14	8-16	4/5/6		
16	8-20	4/5/6		
17	8-20	4/5/6		
18	8-20	4/5/6		

Order printout sample:
1A8S 18 x 20 x 6 x 12 x 8
B126 O6V3 C100

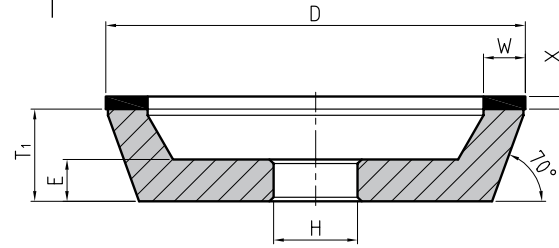

Resin bonded grinding wheels

11A2

D x W x X x H

D	W	X	H	T _{1 min}	E
50	3/4/5	2/3/4	Custom-made	13	8
55	10	2/3/4		15	10
63	3/5/10	2/3/4		15	10
75	3/4/5/6/8/10/15	2/3/4/5		18	10
90	3/4/5/6/8/10	2/3/4/5		22	10
100	3/4/5/6/8/10/1.5/15/20	2/3/4/5		22	10
125	3/4/5/6/8/10/12.5/15/20	2/3/4/5/6		23	10
150	3/4/5/6/8/10/12.5/15/20/25	2/3/4/5/6		23	10
175	3/4/5/6/8/10/12.5/15/20/25	2/3/4/5/6		23	12
200	4/5/6/8/10/12/15/20/25	2/3/4/5/6		23	12
220	4/10/15/20	2/3/4/5/6		25	12
250	5/6/8/10/12/15/25	2/3/4/5/6		25	15

Vitrified bonded grinding wheels

11A2

D x W x X x H

D	W	X	H	T _{1 min}	E
100	6/8/10/12.5/15/20	4-6	Custom-made	22	10
125	6/8/10/12.5/15/20	4-6		23	10
150	6/8/10/12.5/15/20/25	4-6		23	10
175	6/8/10/12.5/15/20/25	4-6		23	12
200	6/8/10/12/15/20/25	4-6		23	12
220	10/15/20	4-6		25	12
250	8/10/12/15/25	4-6		25	15

Order printout sample:
 11A2 100 x 8 x 6 x 20
 B107 P4V3 C100



Resin bonded grinding wheels

1A2M

D x W x X x H

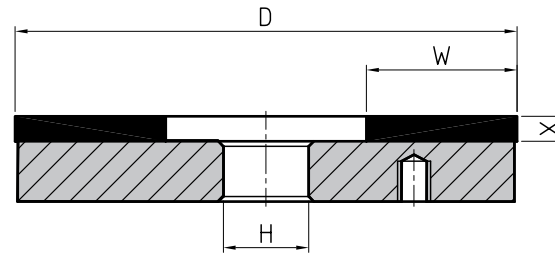

D	W	X	H
300	140	5	Custom-made
400	130	5	
400	150	5	
400	175	5	
500	180	5	
600	150	5/10	
600	230	5/10	

1M2

D x W x X x H

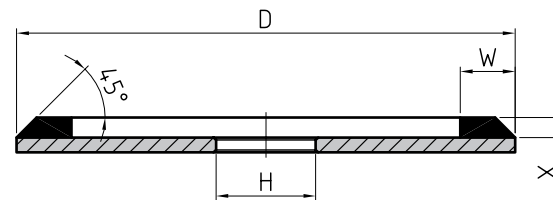

D	W	X	H
125	3/5	1/1.5/2	Custom-made
150	3/5	1/1.5/2	

Order printout sample:
 1M2 125 x 5 x 2 x 20
 D64 B40S C75

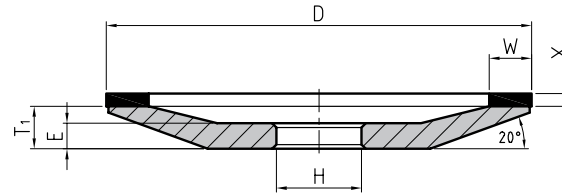

Resin bonded grinding wheels

12A2/20°

D x W x X x H

D	W	X	H	T ₁	E
50	3/4/5/10	2/3/4	Custom-made	7	5
55	10	2/3/4		7	5
63	3/5/10	2/3/4		9	6
75	3/4/5/6/8/10/15	2/3/4/5		9	6
90	3/4/5/6/8/10	2/3/4/5		10	6
100	3/4/5/6/8/10/12.5/15/20	2/3/4/5		10	6
125	3/4/5/6/8/10/12.5/15/20	2/3/4/5/6		14	8
150	3/4/5/6/8/10/12.5/15/20/25	2/3/4/5/6		16	9
175	3/4/5/6/8/10/12.5/15/20/25	2/3/4/5/6		18	10
200	4/5/6/8/10/12/15/20/25	2/3/4/5/6		20	11
220	4/10/15/20	2/3/4/5/6		23	13
250	5/6/8/10/12/15/25	2/3/4/5/6		23	13

Vitrified bonded grinding wheels

12A2/20°

D x W x X x H

D	W	X	H	T ₁	E
100	6/8/10/12.5/15/20	4-6	Custom-made	10	8
125	6/8/10/12.5/15/20	4-6		14	10
150	6/8/10/12.5/15/20/25	4-8		16	9
175	6/8/10/12.5/15/20/25	5-10		18	10
200	6/8/10/12/15/20/25	6-12		20	11
220	10/15/20	6-15		23	13
250	8/10/12/15/25	5-10		23	13

Order printout sample:
12A2/20° 125 x 10 x 6 x 20
D91 P3V C125

Resin bonded grinding wheels
12A2/45°

D x W x X x H

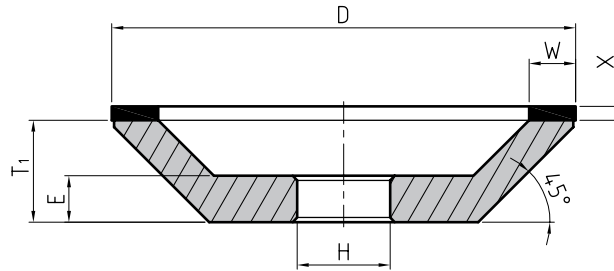

D	W	X	H	T ₁	E
50	3/4/5/10	2/3/4	Custom-made	20	8
55	10	2/3/4		20	8
63	3/5/10	2/3/4		20	8
75	3/4/5/6/8/10/15	2/3/4/5		20	10
90	3/4/5/6/8/10	2/3/4/5		22	10
100	3/4/5/6/8/10/12.5/15/20	2/3/4/5		22	10
125	3/4/5/6/8/10/12.5/15/20	2/3/4/5/6		22	10
150	3/4/5/6/8/10/12.5/15/20/25	2/3/4/5/6		22	10
175	3/4/5/6/8/10/12.5/15/20/25	2/3/4/5/6		25	12
200	4/5/6/8/10/12/15/20/25	2/3/4/5/6		25	12
220	4/10/15/20	2/3/4/5/6		25	12
250	5/6/8/10/12/15/25	2/3/4/5/6		25	12

Vitrified bonded grinding wheels
12A2/45°

D x W x X x H

D	W	X	H	T ₁	E
100	6/8/10/12.5/15/20	4-6	Custom-made	22	10
125	6/8/10/12.5/15/20	4-6		22	10
150	6/8/10/12.5/15/20/25	4-6		22	10
175	6/8/10/12.5/15/20/25	5-10		25	12
200	6/8/10/12/15/20/25	6-12		25	12
220	10/15/20	6-5		25	12
250	8/10/12/15/25	6-15		25	12

 Order printout sample:
 12A2/45° 150 x 8 x 6 x 20
 B126 O6V3 C100

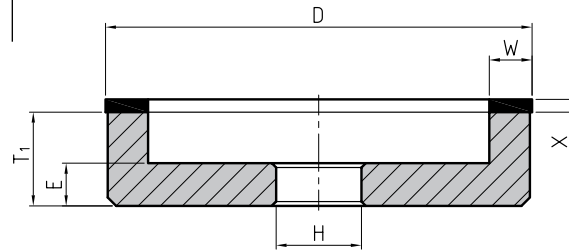

Resin bonded grinding wheels

6A2

D x W x X x H

D	W	X	H	T ₁	E
30	3/5	2/3	Custom-made	18	8
40	3/5	2/3		20	8
45	3/4	2/3		20	8
50	3/4/5/10	2/3/4		20	10
55	10	2/3/4		20	10
63	3/5/10	2/3/4		20	10
75	3/4/5/6/8/10/15	2/3/4/5		20	10
90	3/4/5/6/8/10	2/3/4/5		22	10
100	3/4/5/6/8/10/12.5/15/20	2/3/4/5		22	10
125	3/4/5/6/8/10/12.5/15/20	2/3/4/5/6		22	10
150	3/4/5/6/8/10/12.5/15/20/25	2/3/4/5/6		22	10
175	3/4/5/6/8/10/12.5/15/20/25	2/3/4/5/6		25	13
200	4/5/6/8/10/12/15/20/25	2/3/4/5/6		25	13
220	4/10/15/20	2/3/4/5/6		25	13
250	5/6/8/10/12/15/25	2/3/4/5/6		25	13

Vitrified bonded grinding wheels

6A2

D x W x X x H

D	W	X	H	T ₁	E
100	6/8/10/12.5/15/20	4-10	Custom-made	22	10
125	6/8/10/12.5/15/20	4-10		22	10
150	6/8/10/12.5/15/20/25	4-10		22	10
175	6/8/10/12.5/15/20/25	4-10		25	13
200	6/8/10/12/15/20/25	4-10		25	13
220	10/15/20	6-10		25	13
250	8/10/12/15/25	6-12		25	13
300	8/10/12	6-12		30	15

Order printout sample:
 6A2 100 x 6 x 5 x 20
 B126 M6V3 C100



Resin bonded grinding wheels

1L1

D x U x X x H

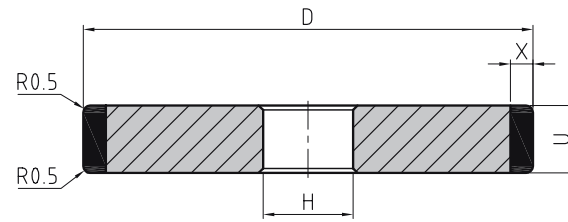

D	U	X	H
75	3/4/5/6/10	2/3/5	Custom-made
100	3/4/5/6/10	2/3/5	
125	3/4/5/6/10	2/3/6	
150	4/5/6/10	3/5/6	
175	6/10/15	3/5/6	
200	6/10/15	3/5/6	

1V1/V°

D x U x X x H

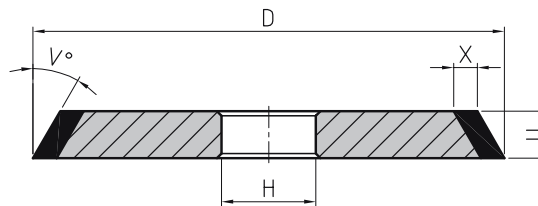

D	U	X	V	H
50	5/10	3/5	10/15/20/30/45	Custom-made
75	6/10	3/5	10/15/20/30/45	
90	6/10	3/5	10/15/20/30/45	
100	6/10/12	3/5/6/8/10	10/15/20/30/45	
125	6/10/12	3/5/6/8/10	10/15/20/30/45	
150	6/10/12	3/5/6/8/10	10/15/20/30/45	

Order printout sample:
 1V1/15° 100 x 6 x 3 x 20
 D91 BP C100



Resin bonded grinding wheels

1C9

D x T x W x X x H

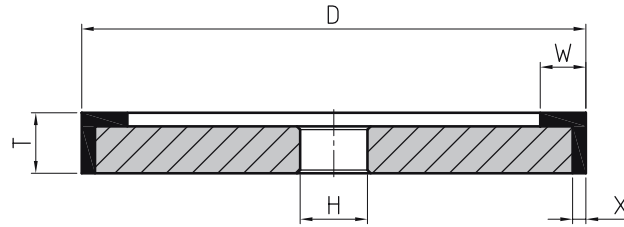

D	T	W	X	H
100	10	10	2	Custom-made
125	10	10	2	
150	10/20	10	2/3	
175	20/25	10	3/4	
200	20/25	10	3/4	

1FF1

D x U x X/R x H

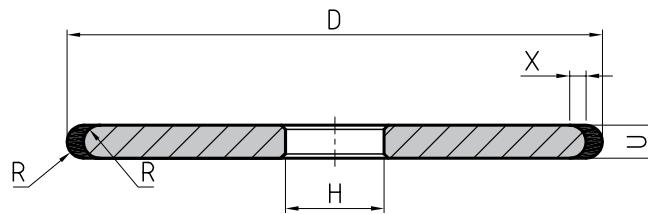

D	U	X	R	H
50	4	2	2	Custom-made
75	4	2	2	
75	8	2	4	
100	5	2	2.5	
125	6	2	3	
125	8	2	4	
125	16	2	8	
150	5	2	2.5	
150	20	2	10	

Order printout sample:
1FF1 125 x 6 x 2/3 x 20
B76 BMR C100

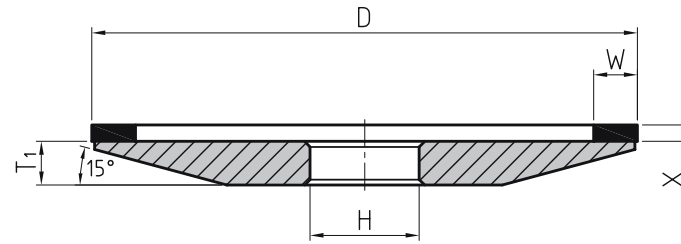

Resin bonded grinding wheels

4A2

D x W x X x H

D	W	X	H	T ₁
50	3/4/5/10	2/3/4	Custom-made	6
55	10	2/3/4		6
63	3/5/10	2/3/4		6
75	3/4/5/6/8/10	2/3/4/5		6
90	3/4/5/6/8/10	2/3/4/5		8
100	3/4/5/6/8/10/12.5/15	2/3/4/5		8
125	3/4/5/6/8/10/12.5/15	2/3/4/5/6		8
150	3/4/5/6/8/10/12.5/15/20	2/3/4/5/6		8
175	3/4/5/6/8/10/12.5/15/20/25	2/3/4/5/6		10
200	4/5/6/8/10/12/15/20/25	2/3/4/5/6		12
220	4/10/15/20	2/3/4/5/6		12
250	5/6/8/10/12/15/25	2/3/4/5/6		14

Vitrified bonded grinding wheels

4A2

D x W x X x H

D	W	X	H	T ₁
100	5/6/8/10/12.5/15	5-8	Custom-made	8
125	5/6/8/10/12.5/15	5-8		8
150	5/6/8/10/12.5/15/20	5-8		8
175	5/6/8/10/12.5/15/20/25	6-10		10
200	5/6/8/10/12/15/20/25	6-10		12
220	10/15/20	6-10		12
250	8/10/12/15/25	8-12		14

Order printout sample:
 4A2 125 x 15 x 6 x 20
 B 107 O 4V3 C 100



Resin bonded grinding wheels

4ET9

D x W x X x H

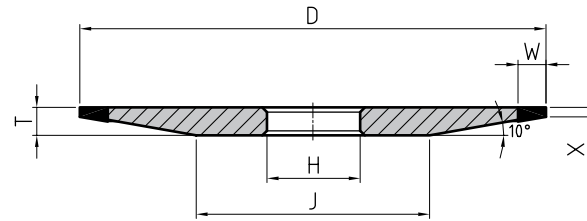

D	W	X	H	T	J
50	6	1/2	Custom-made	4	14/25
75	6/10	1/2		5	27/39
100	6/10	1/2		6	41/52
125	6/10	1/2		8	43/55
150	6/10	1/2		10	43/57
175	6/10	1/2		12	71/82

4BT9

D x W x X x H

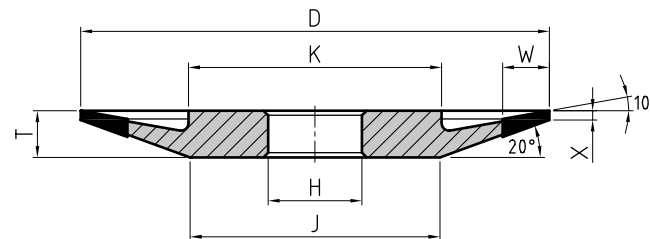

D	W	X	H	T	K=J
50	6/10	1/2	Custom-made	6	20/26
75	6/10	1/2		8	34/40
100	6/10	1/2		10	48/54
125	6/10	1/2		12	62/68
150	6/10	1/2		14	76/82
175	6/10	1/2		14	101/107

Order printout sample:
4BT9 100 x 6 x 2 x 20
D76 B40S C75



Resin bonded grinding wheels

6A9

D x X x U x H

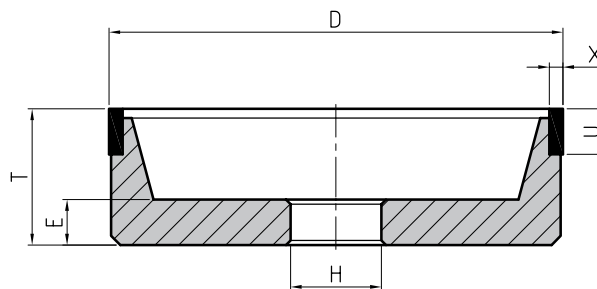

D	X	U	H	T	E
50	2/3	6/10	Custom-made	20	8
75	2/3/4	6/10		25	10
100	2/3/4	6/10		30	10
125	2/3/4	6/10		30	10
150	2/3/4	6/10		35	10
175	3/4/5	6/10		35	10
200	3/4/5	6/10		40	13
220	3/4/5	6/10		40	13
250	3/4/5	6/10		40	13

6C2

D x W x X x U x H

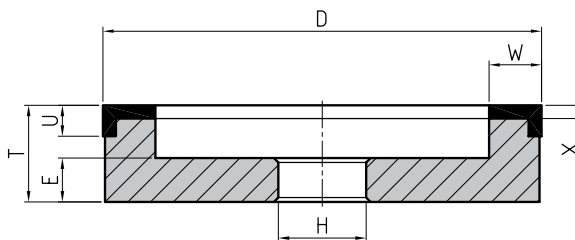

D	W	X	U	H	T	E
100	6/10	3	5/7	Custom-made	22	10
125	6/10	3	5/7		22	10
150	6/10	3	5/7		22	10

Order printout sample:
6C2 100 x 6 x 3 x 5 x 20
D91 V80 C75



Resin bonded grinding wheels

6V9

D x X x U x H

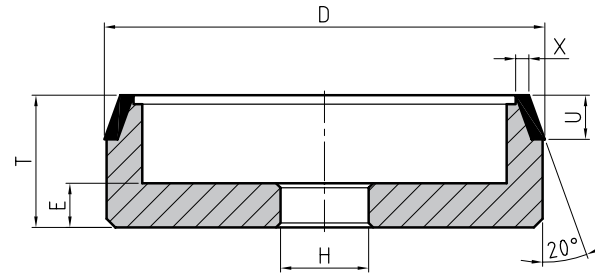

D	X	U	H	T	E
75	2/3	6/10	Custom-made	25	8
100	2/3	6/10		30	10
125	2/3	6/10		35	10
150	2/3	6/10		35	10

12V5/V°

D x W x X x H

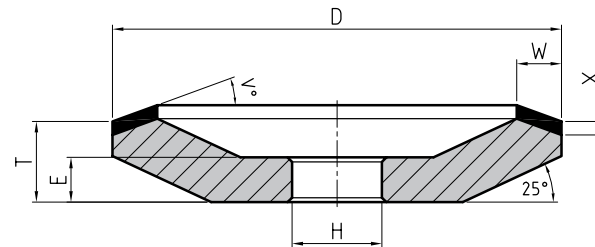

D	W	X	H	T	V	E
75	4/6	2/3	Custom-made	15	10/20	10
100	6/10	2/3		18	10/20	10
125	6/10	2/3		18	10/20	10
150	6/10	2/3		20	10/20	12

Order printout sample:
12V5/10° 100 x 6 x 2 x 20
D76 BMR C75



Resin bonded grinding wheels

9A3

D x W x X x H

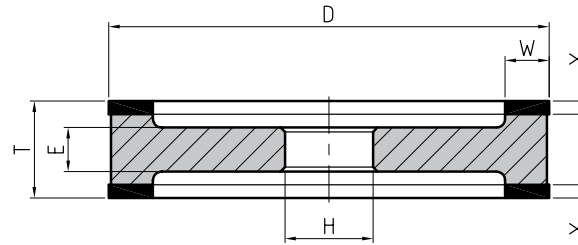

D	W	X	H	T	E
75	6	2/3/4	Custom-made	22	10
100	6/10	2/3/4		22	10
125	6/10	2/3/4		22	10
150	6/10/15	2/3/4		25	14
175	6/10/15	2/3/4		25	14
200	10/15/20	2/3/4		30	18

9U1

D x T x W x X x H

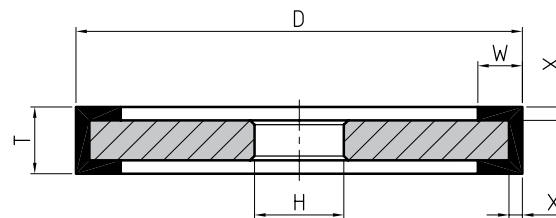

D	T	W	X	H
75	10/15	6/10	2/3	Custom-made
100	10/15	6/10	2/3	
125	10/15	6/10	2/3	
150	10/15	6/10	2/3	
175	10/15	10/15	2/3	
200	10/15	10/15	2/3	

Order printout sample:
 9U1 100 x 10 x 6 x 3 x 20
 B126 BMR C75



Resin bonded grinding wheels

11V9

D x X x U x H

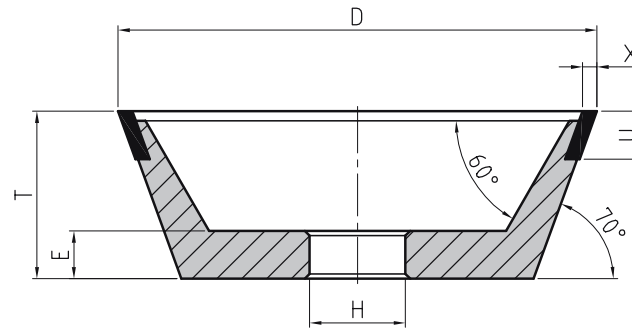

D	X	U	H	T	E
40	1.5/2/3	6	Custom-made	18	8
50	1.5/2/3	6		20	8
75	1.5/2/3	6/10		30	10
90	1.5/2/3	6/10		35	10
100	1.5/2/3	6/10		35	10
125	1.5/2/3	6/10		40	10
150	1.5/2/3	6/10		50	10

Order printout sample:
 11V9 100 x 3 x 10 x 20
 D64 CX100 C100

Resin bonded grinding wheels

12A9

D x W x X x H

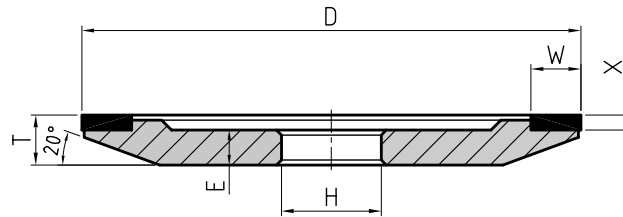

D	W	X	H	T	E
50	3/5	2/3	Custom-made	10	8/7
63	3/5	2/3		10	8/7
75	6/10	2/3		10	8/7
90	6/10	2/3		10	8/7
100	6/10	2/3		10	8/7
125	6/10	2/3		10	8/7
150	6/10/12.5	2/3		12	10/9
175	6/10/12.5	2/3		12	10/9
200	6/10/12.5	2/3		12	10/9

Order printout sample:
 12A9 150 x 6 x 3 x 20
 B151 B47S C75



Resin bonded grinding wheels

12A2/1

D x W x X x H

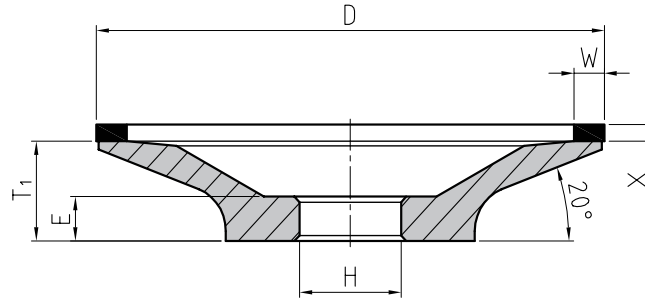

D	W	X	H	T ₁	E
75	3/4/5	2/3	Custom-made	18	8
100	3/4/5	2/3/4		18	8
125	3/4/5	2/3/4		19	9
150	3/4/5	2/3/4		20	10
175	4/5/6	2/3/4		20	10
200	4/5/6	2/3/4		20	10

12V9/25°

D x X x U x H

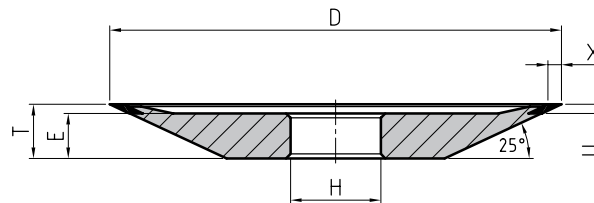

D	X	U	H	T	E
100	3	2	Custom-made	12	10
125	3	2		13	10
150	3	3		16	10

Order printout sample:
 12V9/25° 100 x 3 x 2 x 20
 D46 BMN C50



Resin bonded grinding wheels

12C9/20°

D x W x X/U x H

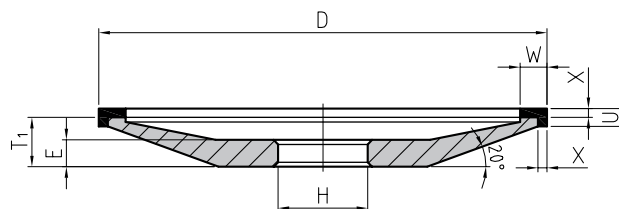

D	W	X	U	H	T ₁	E
50	3/5	1	2	Custom-made	8	5
75	6/8/10	2	4		8	5
100	6/10/15	2/3	4/5		9	6
125	6/10/15	2/3	4/5		13	8
150	8/10/15	2/3	4/5		15	9

12C9/45°

D x W x X/U x H

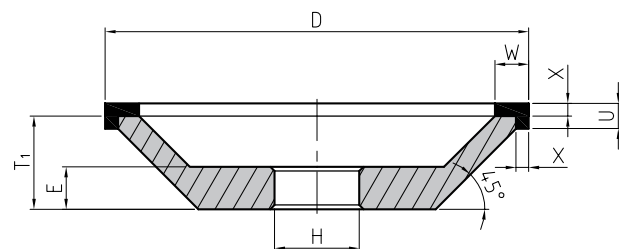

D	W	X	U	H	T ₁	E
50	3/5	1	2	Custom-made	18	10
75	6/8/10	2	4		22	10
100	6/10/15	2/3	4/5		22	10
125	6/10/15	2/3	4/5		22	10
150	8/10/15	2/3	4/5		22	10

Order printout sample:
 12C9/45° 100 x 10 x 3/5 x 20
 D107 B40S C100



Resin bonded grinding wheels

14U1

D x U x W x X x H

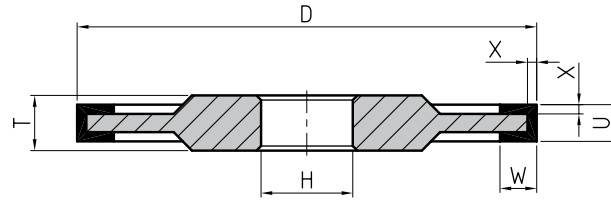

D	U	W	X	H	T
75	6	6/10	2	Custom-made	U+2
75	8/10	6/10	2/3		
100	6/8/10	6/10	2/3		
125	6/8/10	6/10	2/3		
150	6/8/10	6/10/15	2/3		
175	6/8/10	6/10/15	2/3		
200	6/8/10	6/10/15	2/3		

1.4

TOOL GRINDING AND SHARPENING



Resin bonded grinding wheels

15V9/V_z^o

D x X x U x H

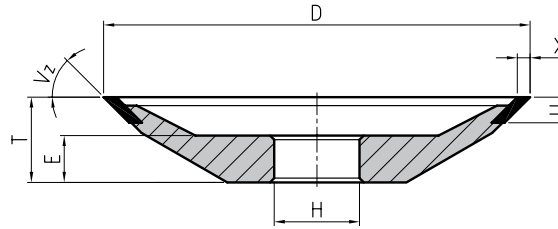

D	X	U	H	T	E	V _z ^o
75	2/3	6	Custom-made	13	6	45
85	2/3	6		15	8	45
100	2/3	6		20	11	30
100	2/3	6		20	11	45
125	2/3	6		20	11	30
125	2/3	6		20	11	45
150	2/3	6		20	11	30
150	2/3	6		20	11	45
175	2/3	8		25	11	45
200	2/3	6		25	11	45

12V2

D x W x X x H

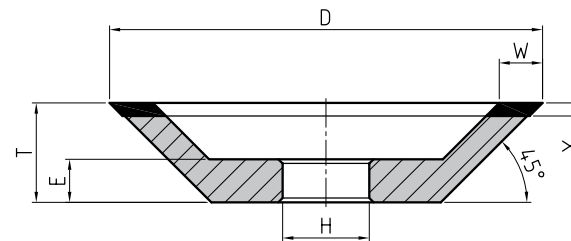

D	W	X	H	T	E
50	5/10	2/3	Custom-made	15	8
75	6/10	2/3		20	10
90	6/10	2/3/4		23	10
100	6/10	2/3/4		23	10
125	6/10/12.5	2/3/4		23	10
150	6/10/12.5	2/3/4		23	10

Order printout sample:
12V2 100 x 10 x 3 x 20
D64 BMR C75



1.5

TOOL GRINDING AND SHARPENING IN THE WOOD INDUSTRY



Resin bonded grinding wheels

VB - 4B9

D x X x U x H

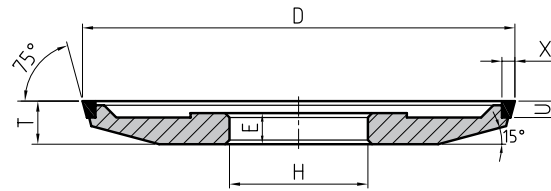

D	X	U	H	T
75	X	3	32	10
100	3	1.8	32	9
100	3	3.0	32	10
100	3	3.8	32	10
100	3	4.0	32	10
125	4.5	1.8	32	12
125	3	3.8	32	14
150	3	1.8	32	12
150	3	3.8	32	14

VD - 6A2DV

D x W x U x H

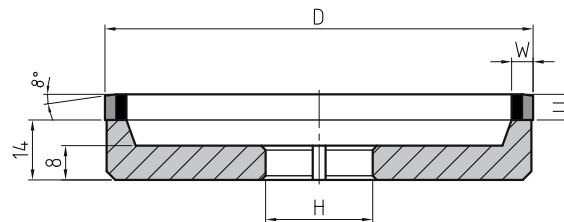

D	W	U	H
75	5	3-6	25
100	5/6	3-12	25
125	5/6	3-12	25
150	5/6	3-10	25
175	5	10	25

Order printout sample:
 VD - 6A2DV 100 x 6 x 6 x 25
 D126/46 BMR/BMR C100/75



Resin bonded grinding wheels

VB - 6A2DV

D x W x U x H

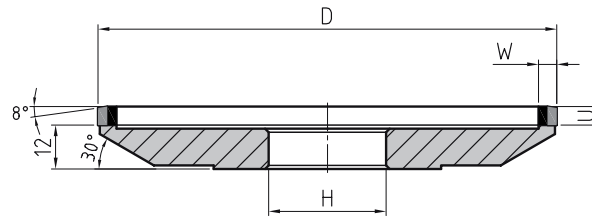

D	W	U	H
75	5	3-6	32
100	5/6	3-12	32
125	5/6	3-12	32
150	5/6	3-10	32
175	5	10	32

6A2-TR

D x W x U x H

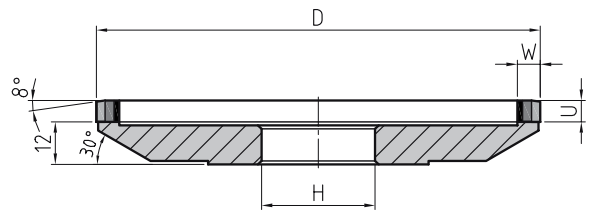

D	W	U	H
100	5.5	6	Custom-made
125	6.5	6	
150	6	8	
200	6	10	

Order printout sample:

6A2-TR 125 x 6.5 x 6 x 32

D107/35/15 BMR/BMR/BMR C75/C75/C75



Resin bonded grinding wheels

6A2 - DVU

125 x 8 x 5 x 32

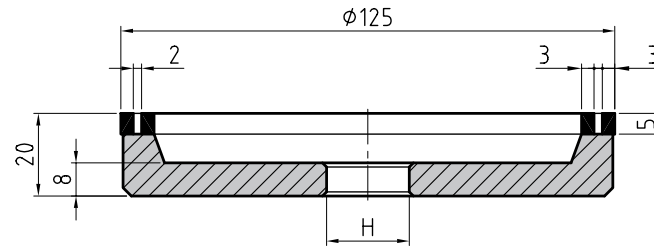

VD - 4B9

D x X x U x H

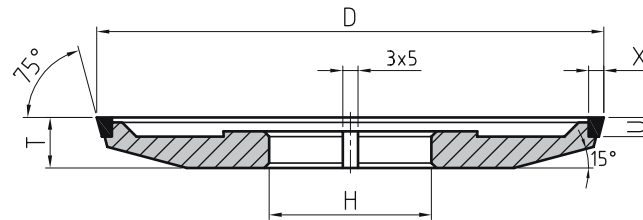

D	X	U	H	T
75	3	3	25	10
100	3	1.8	25	9
100	3	3.0	25	10
100	3	3.8	25	10
100	4.5	4.0	25	10
125	3	1.8	25	12
125	3	3.8	25	14
150	3	1.8	25	12
150	3	3.8	25	14

Order printout sample:
VD - 4B9 100 x 3 x 1.8 x 25
D64 BMR C75



Resin bonded grinding wheels

1SM

D x W x U/Z x H

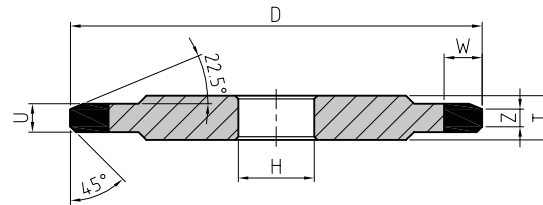

Drill d/mm	D	W	U	Z	H	T
4	75/100	6	4.5	0.9	Custom-made	8
6	75/100	6	4.5	1.9		8
8	75/100	6	5.0	2.8		8
10	75/100	6	6.4	3.7		10
12	75/100	6	7.4	4.7		10
14	75/100	6	8.4	5.7		10

Order printout sample:
1SM 100 x 6 x 6.4/3.7 x 20
B107 V80 C100

US - 1A1W

D x T x X x Y x L

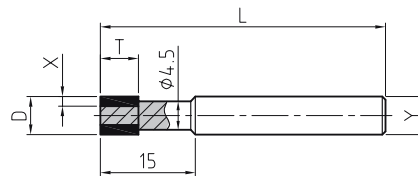

D	T	X	Y	L
6	6/3	1.5	6	45
6.5	6/3	1.75	6	45
7	6/3	2	6	45
8	6/3	2	6	45

Order printout sample:
US - 1A1W 6.5 x 3 x 1.75 x 6 x 45
D46 CX100 C100

VD-12A1

100 x 4 x 4 x 20

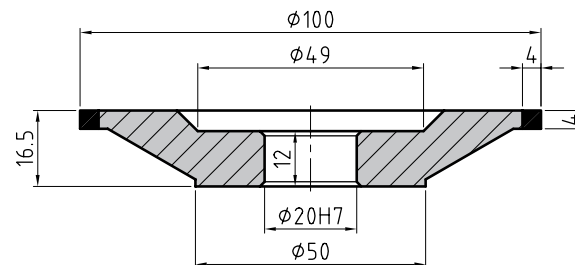



Resin bonded grinding wheels

4V2

125 x 4 x 2 x 32

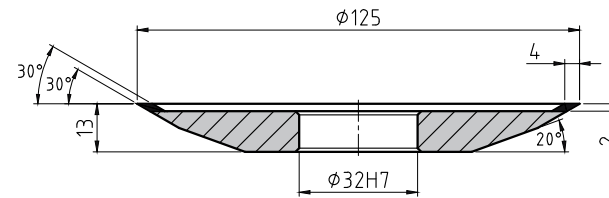

VB - 12B9

100 x 4 x 5 x 32

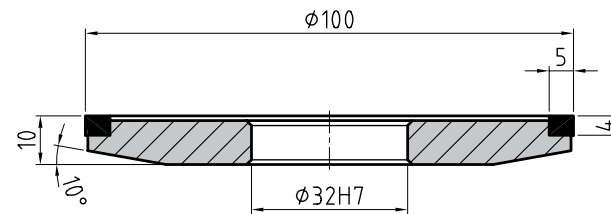

VD - 12B9

100 x 4 x 4,5 x 20

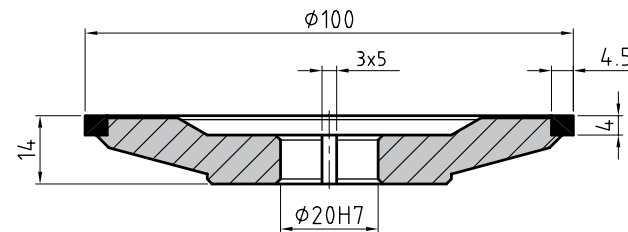

6A2G

200 x 6 x 2 x 50

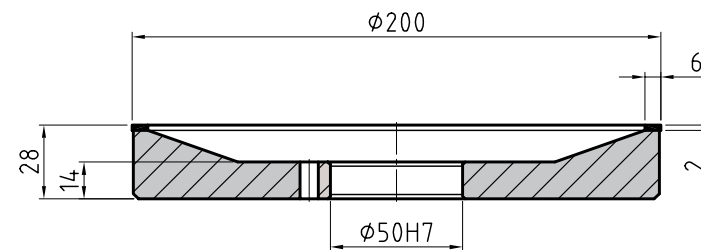

Order printout sample:
6A2G 200 x 6 x 2 x 50
D15 BMR C50



Resin bonded grinding wheels

3F1

D x X x H x R x V°

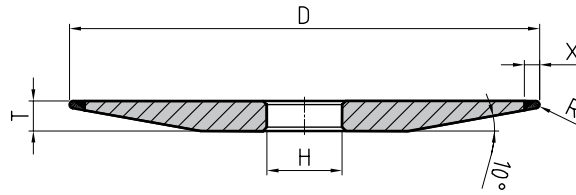

D	X	H	R	V°	T
100	4	Custom-made	1	10	6
125	4		1	10	8
150	4		1	10	10

4C2R

D x W x X/X1 x U x H x R

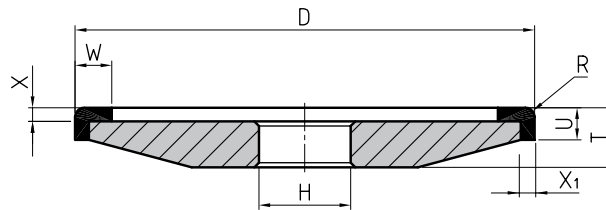

D	W	X	X ₁	U	H	R	T
100	5	2	3	4.4	Custom-made	2.5	10
125	5	2	3	4.4		2.5	10

Order printout sample:
 4C2R 125 x 5 x 2/3 x 4.4 x 20 x 2.5
 D15 BMR C75



Resin bonded grinding wheels

14EE1

D x U x X/V° x H

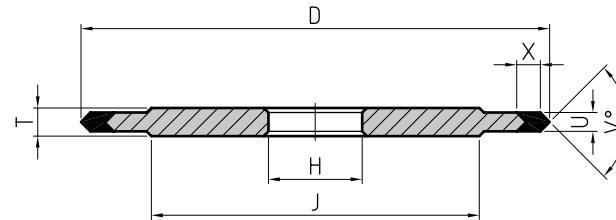

D	U	X	V°	H	T	J
75	3	3	35	Custom-made	6	50
75	3	3	60		6	50
75	4	3	35		6	50
75	4	3	45		6	50
75	4	3	60		6	50
75	4	3	90		6	50
100	3	3	35		6	70
100	3	3	45		6	70
100	3	3	60		6	70
100	3	3	90		6	70
100	4	3	35		6	70
100	4	3	45		6	70
100	4	3	60		6	70
100	4	3	90		6	70

D	U	X	V°	H	T	J
125	3	3	35	Custom-made	6	100
125	3	3	45		6	100
125	3	3	60		6	100
125	3	3	90		6	100
125	4	3	35		6	100
125	4	3	45		6	100
125	4	3	60		6	100
125	4	3	90		6	100
150	3	3	35		6	120
150	3	3	45		6	120
150	3	3	60		6	120
150	3	3	90		6	120
150	4	3	35		6	120
150	4	3	45		6	120
150	4	3	60		6	120
150	4	3	90		6	120

Order printout sample:
 14EE1 100 x 3 x 3/45° x 20
 D64 CX100 C100

1.6

PROFILE GRINDING

Resin bonded grinding wheels

14A1

D x U x X x H

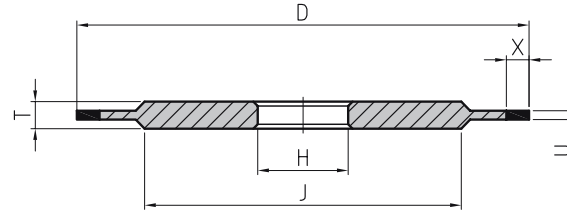

D	U	X	H	T	J
50	1.0-5.0	5	Custom-made	6	30
75	1.0-5.0	3/5		6	50
100	1.0-5.0	5		6	70
125	1.0-5.0	5		6	95
150	1.0-5.0	5/8		5/8/10	120
175	1.0-5.0	5/8		5/8/10	140
200	1.0-5.0	5/8		5/8/10	160
250	1.0-5.0	8		5/8/10	200

14F1

D x U x X/R x H

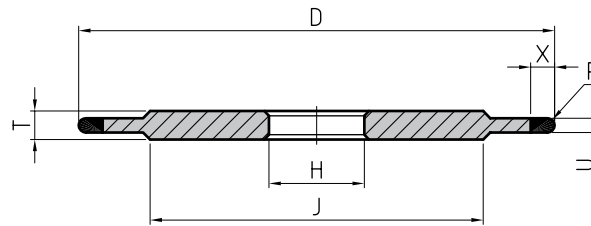

D	U	X	R	H	T _{min}	J
50	1.0-5.0	5	U/2	Custom-made	6	30
75	1.0-5.0	3/5	U/2		6	50
100	1.0-5.0	5	U/2		6	70
125	1.0-5.0	5	U/2		6	95
150	1.0-5.0	5/8	U/2		5/8/10	120
175	1.0-5.0	5/8	U/2		5/8/10	140
200	1.0-5.0	5/8	U/2		5/8/10	160
250	1.0-5.0	8	U/2		5/8/10	200

Order printout sample:
14F1 150 x 2 x 5/1 x 20
D126 V80T C100



1.7

CNC TOOL GRINDING

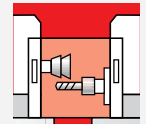

Resin bonded and grinding wheels Hybrid bonded

1A1

D x U x X x H

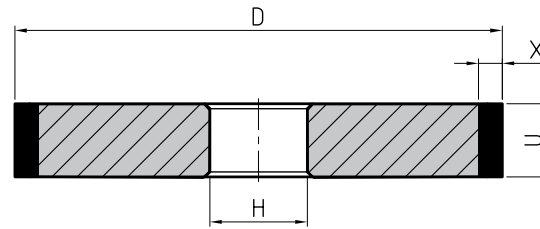

D	U	X	H
50	4-12	4/5	Custom-made
75	4-12	6/10	
100	6-15	6/10	
125	6-15	6/10	
150	5-10	6/10	

1V1/V°

D x U x X x H

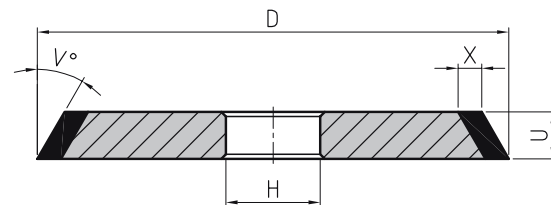

D	U	X	V°	H
75	6-10	6/10	≤45	Custom-made
100	6-12	6/10	≤45	
125	6-12	6/10	≤45	
150	8-12	6/10	≤45	

Order printout sample:

1V1/15° 100 x 12 x 6 x 20

D64 HYB4 C100

CNC TOOL GRINDING



Resin and Hybrid bonded grinding tools

11V9

D x X x U x H

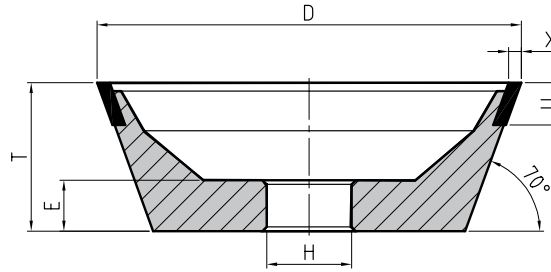

D	X	U	E	T	H
75	2/3/5	6/10	12	30	Custom-made
100	2/3/5	6/10	12	35	
125	2/3/5	6/10	12	35	

12V9

D x X x U x H

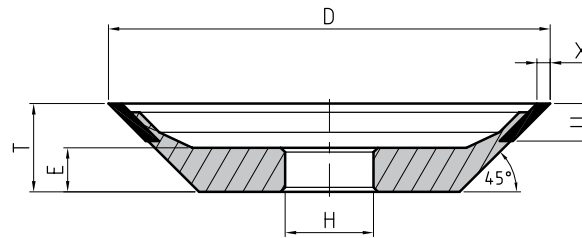

D	X	U	E	T	H
75	2/3	6/10	10	20	Custom-made
100	2/3	6/10	10	20	
125	2/3	6/10	10	25	

Order printout sample:
 112V9 125 x 3 x 10 x 20
 B107 PIMR C100



1.8

CUTTING-OFF



Resin bonded grinding wheels

1A1R

D x U x X x H

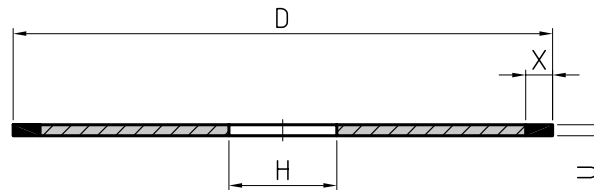

D	U=T	X	H
50	0.8-2.0	5	Custom-made
75	0.8-2.0	3/5	
100	0.8-2.0	5	
125	0.8-2.0	5	
150	0.8-2.0	5/8	
175	1.0-2.0	5/8	
200	1.0-2.0	5/8	
250	1.5-2.0	8	
300	1.0-2.0	8	
350	2.0-3.0	8	
500	3.2	6.4	

Order printout sample:
 1A1R 200 x 1.5 x 5 x 20
 D151 BMEG C100



Resin bonded grinding wheels

1A1R-O

D x U x H

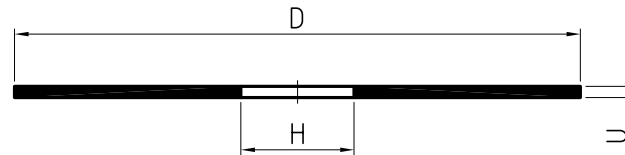

D	U	H
22	0.3-1.0	10
25	0.3-1.0	10
30	0.3-1.0	10
40	0.3-1.0	10
45	0.3-1.0	10
50	0.3-1.0	10
75	0.3-1.0	20
100	0.3-1.0	20

Order printout sample:
 1A1R-O 50 x 1 x 10
 B107 PIMR C100



Resin bonded grinding wheels

1F1R

D x U x X x H

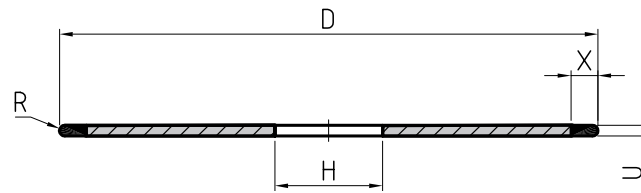

D	U	X	H	R
50	0.8-2.0	5	Custom-made	U/2
75	0.8-2.0	3/5		
100	0.8-2.0	5		
125	0.8-2.0	5		
150	0.8-2.0	5/8		
175	1.0-2.0	5/8		
200	1.0-2.0	5/8		
250	1.5-2.0	8		
300	1.0-2.0	8		
350	1.2-2.5	8		
500	3.2	6.4		

Order printout sample:
 1F1R 150 x 1.5 x 5 x 20
 B126 BM1R C100

Vitrified bonded grinding wheels

6A2

D x W x X x H

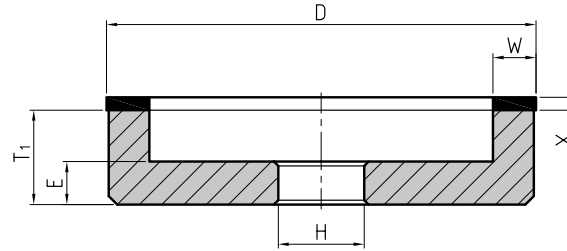

D	W	X	H	T ₁	E
100	6/8/10/12.5/15	4-6	25	22	10
125	6/8/10/12.5/15	4-6	25	22	10
150	6/8/10/12.5/15	4-6	25/40	22	10
175	6/8/10/12.5/15	4-6	25/40	25	13
200	6/8/10/12/15	4-6	25/40	25	13

11A2

D x W x X x H

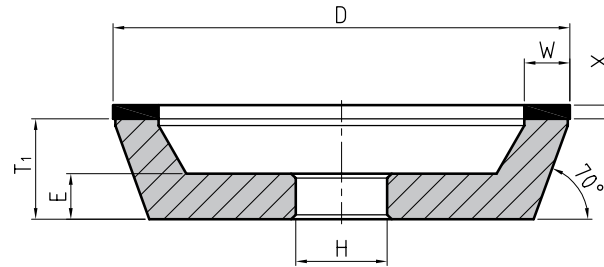

D	W	X	H	T ₁	E
100	6/8/10/12.5/15	4-6	25	22	10
125	6/8/10/12.5/15	4-6	25	22	10
150	6/8/10/12.5/15	4-6	25/40	22	10

Order printout sample:
 14A2 150 x 10 x 5 x 20
 B126 O4V3 C100

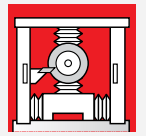

Vitrified bonded grinding wheels

12A2/45°

D x W x X x H

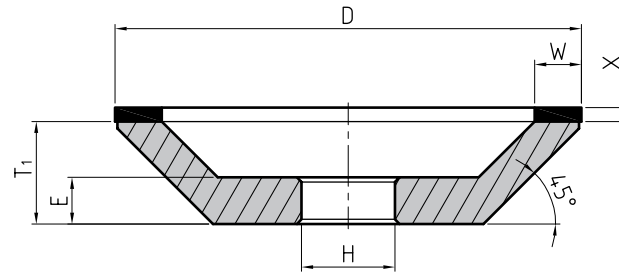

Order printout sample:
12A2/45° 125 x 10 x 5 x 40
D46 P3V C125

D	W	X	H	T ₁	E
100	6/8/10/12.5/15/20	4-6	25	22	10
125	6/8/10/12.5/15/20	4-6	25	22	10
150	6/8/10/12.5/15/20/25	4-6	25/40	22	10

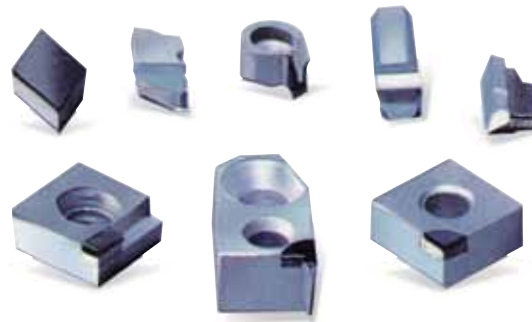







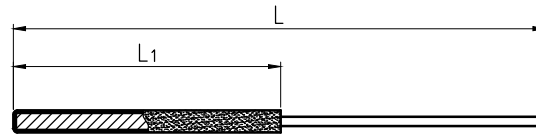

Electroplated grinding wheels

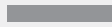
RP

RP - description



RP	Description	L_1	L	Cross-section dimensions
	Flat	70	140	5.1 x 1.4
	Triangle			3.9
	Square			2.5
	Semi-circular			5.4 x 1.9
	Circular			3.0
	Set			/

Order printout sample:

RP - flat 126

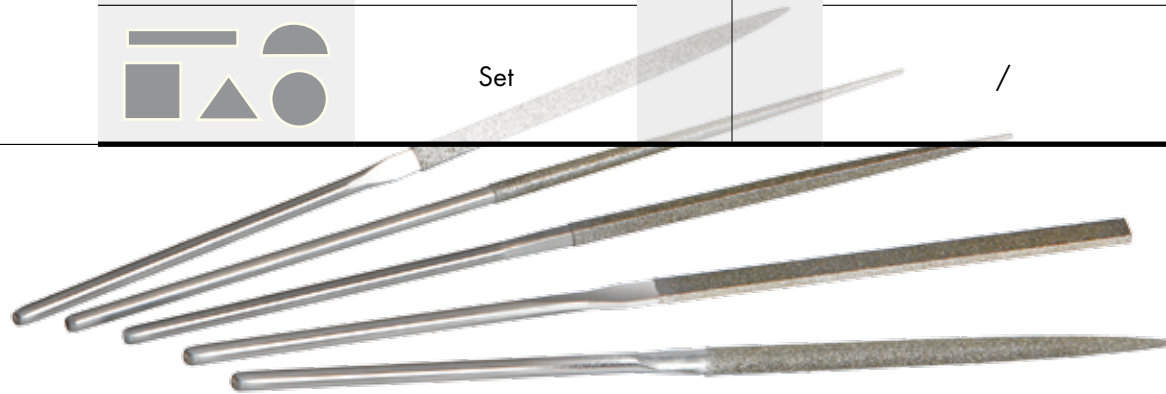



Diamond polishing slurries

DIA SLURRY

DIA SLURRY - type



Type	Average grit size µm	Application
DIA SLURRY 1/10 MIC.	0-1/4	Super finish
DIA SLURRY 1/4 MIC.	0-1/2	Super finish
DIA SLURRY 1 MIC.	0-2	Fine polishing
DIA SLURRY 2 MIC.	1/2-3	Fine polishing
DIA SLURRY 3 MIC.	1-4	Fine polishing
DIA SLURRY 4 MIC.	2-6	Fine polishing
DIA SLURRY 6 MIC.	4-8	Pre-polishing
DIA SLURRY 8 MIC.	5-10	Pre-polishing
DIA SLURRY 14 MIC.	9-18	Pre-polishing
DIA SLURRY 25 MIC.	18-40	Coarse polishing
DIA SLURRY 45 MIC.	40-60	Coarse polishing
DIA SLURRY 60 MIC.	50-80	Coarse polishing
DIA SLURRY 80 MIC.	60-100	Coarse polishing

Order printout sample:
DIA SLURRY 1/10 MIC.

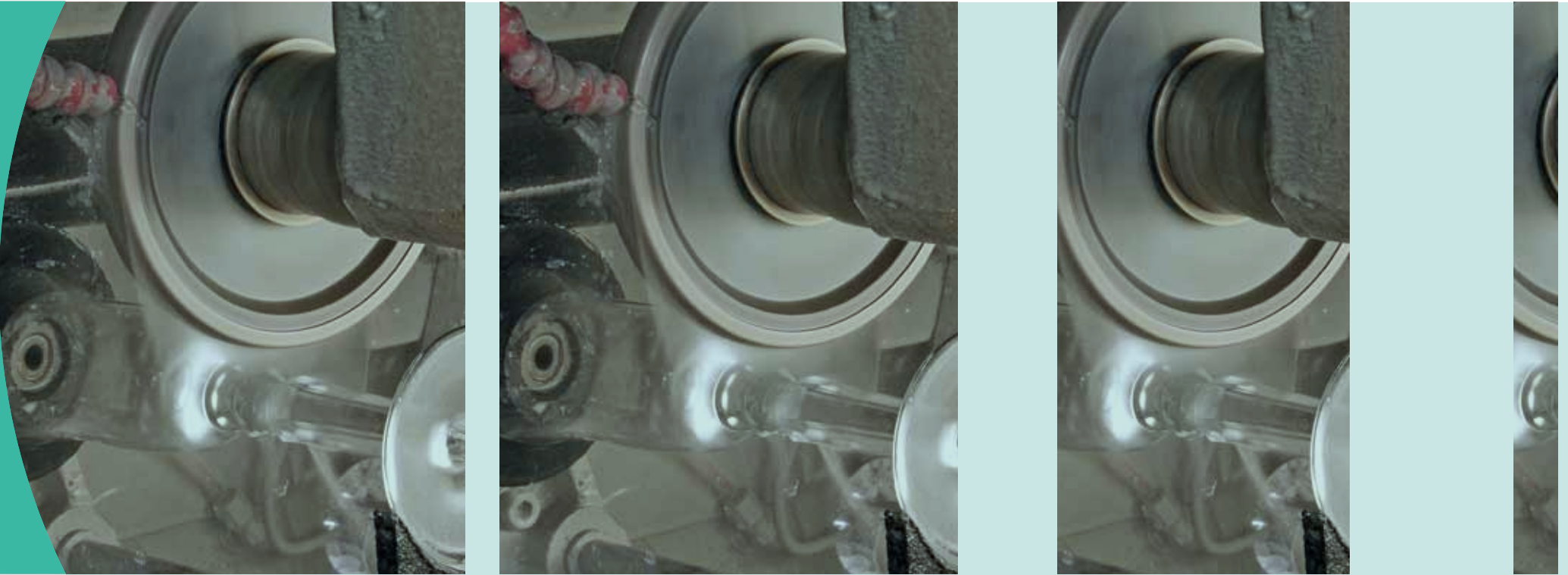

2

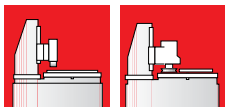

	2.1	Decorative glass grinding	79-85
	2.2	Grinding, cutting and drilling of flat glass	86-88
	2.3	Laboratory glass grinding and drilling	89-91

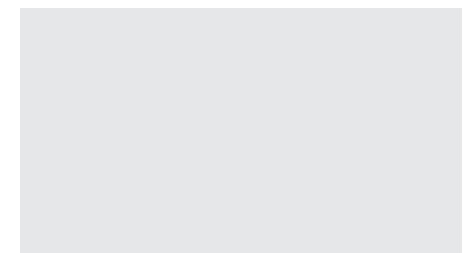
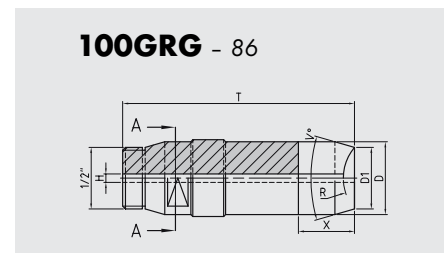
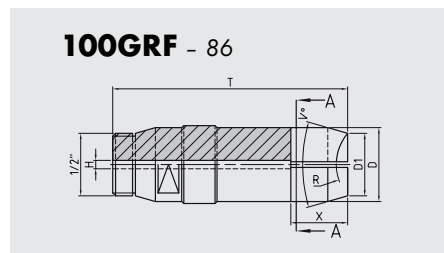
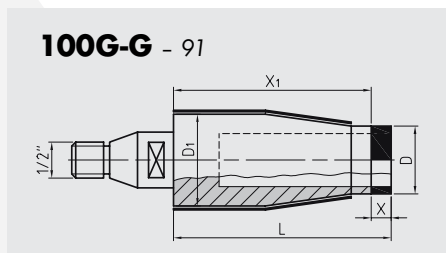
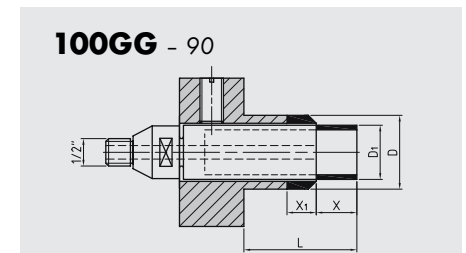
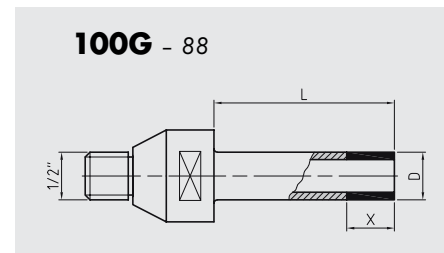
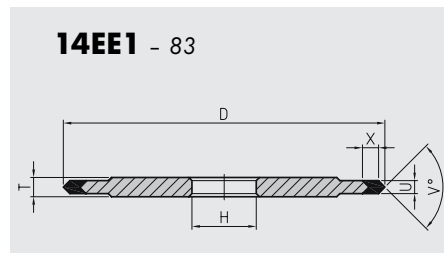
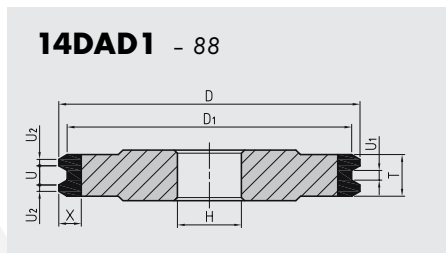
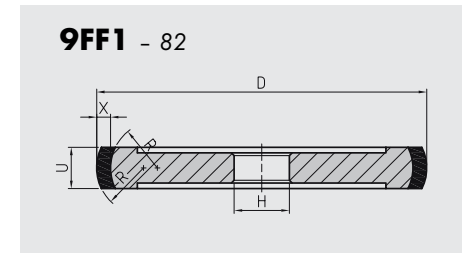
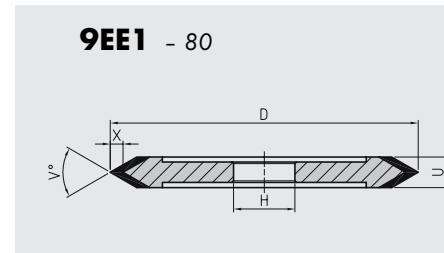
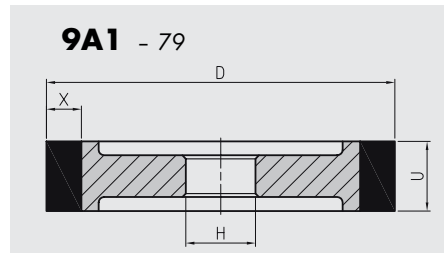
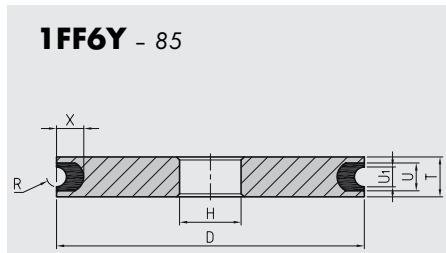
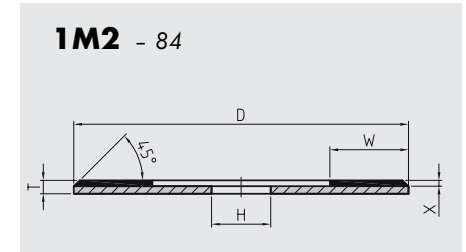
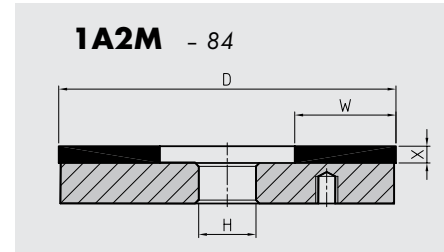
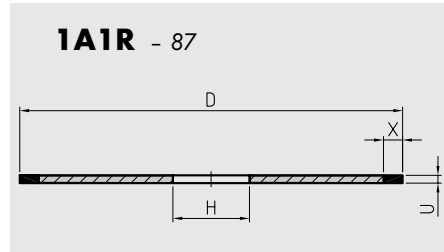
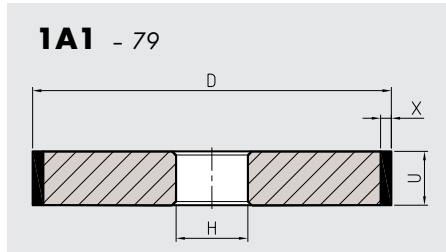



2.1

DECORATIVE GLASS GRINDING



Metal bonded grinding wheels

1A1

D x U x X x H

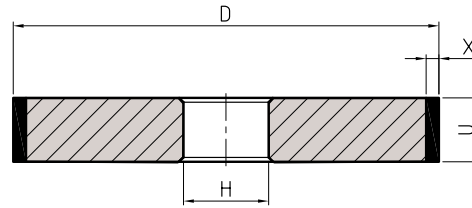

9A1

D x U x X x H

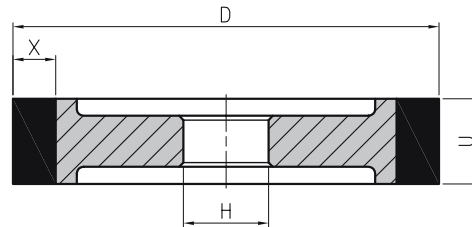

D	U	X	H
80	20	10/20	Custom-made
80	35	10	
80	40	5	
90	35	10/15	
100	35	10/15	
100	50	10	
110	35/40	10	
150	50	10/20	
200	15	20	
200	16	10	
200	20	10	
200	50	5/10	
200	18	20	
250	30	10	
250	35	20	
300	30	10	

Order printout sample:
 1A1 150 x 50 x 20 x 42
 D181 MB17 C50



Metal bonded grinding wheels

9EE1

D x U x X x H x V°

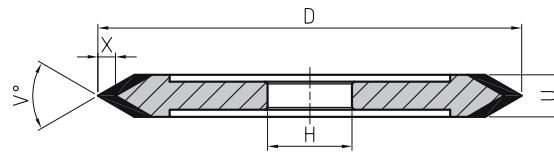

D	U	X	H	V°
40	10	6	Custom-made	100
40	25	5		135
50	10	5		140
50	10	10		90/140
50	15	5		115
50	20	5		85/110
50	25	5		90
50	25	10		110/115/140
60	15	10		115
70	10	10		115/130
70	10	20		110
70	15	10		120
70	20	10		85/100/110/135
70	25	10		115
80	10	10		100
100	10	10		110
100	13	10		100/110/115/130
100	16	10		115
100	20	10		110
100	25	10		115/140
110	10	10	100/110/115	
110	15	20	110/120	
110	20	10	115	



D	U	X	H	V°
110	25	8	Custom-made	100
110	25	10		100/130
120	10	20		110
120	13	10		130
120	15	20		100/110/115/120/130
120	20	10		140
120	25	10		65/100/110
150	10	10		90
150	13	10		90/110
150	13	20		110
150	13	30		110/115
150	15	10		65/90/95/110/115
150	15	20		100/115/130
150	20	10		85/90/105/120
150	25	20		85/90/115
150	30	20		90
150	32	10		110
150	35	10		90/115/140
150	40	10		90/115
150	45	10		110/120
150	50	10		110
200	15	10		115/140
200	15	20		115
200	16.5/21	2		90
200	20	10		90
200	25	10		120/140
200	35	10		100
200	8	10		120/135
250	15	10	115	
250	20	10	90/110	

Order printout sample:
 9EE1 100 x 20 x 10 x 60 x 110
 D46 MB02 C42



Metal bonded grinding wheels

9FF1

D x U x X x H x R

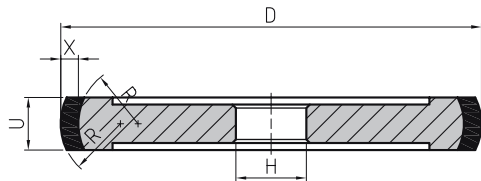

D	U	X	H	R
30	10	8.5		10
50	20	10		20
60	10	10		40
60	20	15		20
60	25	10		20
70	20	10		40
90	20	10		10
100	15/16	10		40
100	20	10		30
100	25	10		20
100	35	10		50
110	25	10		10/20
120	15	5		8
120	20	10		15
120	25	20		20/25/30
120	30	10	Custom-made	50
120	35	10		60
120	35	20		50
150	10	10		12
150	13	10		8
150	16	10		8/40
150	20	10		10
150	25	10		40
150	30	10		15
150	40	10		60
180	20	10		50
180	30	10		60
200	13	10		13
200	20	10		10/20
200	25	10		15
200	35	10		50
250	20	10		10/21/50/90
250	30	10		30
250	35	10		20/50/60/90

Order printout sample:
 9FF1 120 x 20 x 10 x 42 x R15
 D181 MB17 C50



Metal bonded grinding wheels

14EE1

D x U x X x H x V°

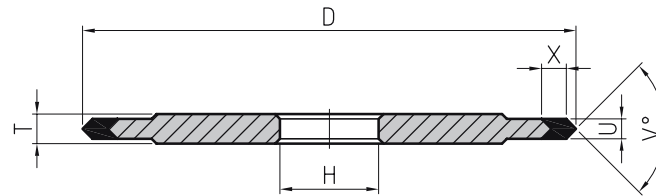

D	U	X	H	V°	T
45	13	5	Custom-made	120	U+4
50	8	10		115	
70	6	10		65	
70	10	20		110	
75	10	10		100	
100	6	10		115	
100	8	10		80/100/130	
110	10	10		115	
120	6	10		100	
120	8	5/10		110	
120	10	10		115	
120	10	20		110	
140	8	10		80/90/110	
150	10	10		110/115	
150	10	20		110	
150	10	30		115	
200	6	10	100		
200	8	10	100/120		

Order printout sample:
 14EE1 120 x 10 x 10 x 40 x 115
 D39 MB02 C42



Resin bonded grinding wheels

1A2M

D x W x X x H

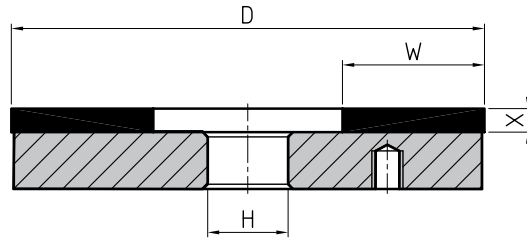

D	W	X	H
300	140	5	Custom-made
400	130/150/175	5	
500	180	5	
600	150/230	6/10	

Metal bonded grinding wheels

1M2

D x W x X x T x H

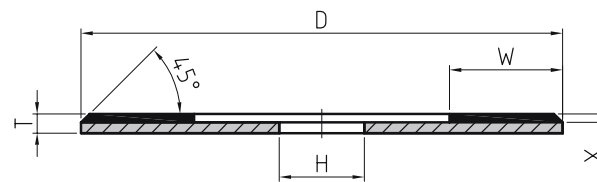

Order printout sample:
 1M2 200 x 30 x 0.5 x 1.3 x 24
 D54 BB01 C50

D	W	X	T	H
200	30/40	0.5	1.3	24



Metal bonded grinding wheels

1FF6Y

D x U/U₁ x X x H x R

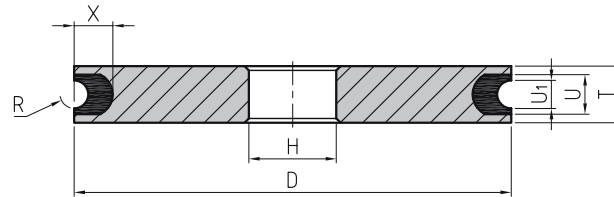

D	U/U ₁	X	T	H	R
100	5/3.7	5	U+4	Custom-made	1.8-2.2
100	6/3.6	5			1.1-1.8
100	9/7	5			3
100	10/8	10			4
100	12/8	10			4.2
100	13/8	10			4.2
100	15/13	10			6.5
100	18/16	10			8
100	22/20	10			10.2
150	9/5	5			2.5
175	5/3.2	5	4		
175	10/9	5	5		
175	13/11	5	6		
200	5.7/2.9	5	1.5		
200	5.7/3.6	5	1.8		
200	5.7/3.7	5	1.9		
200	5/3.2	5	1.6		
200	6/3.7	5	1.9		

Order printout sample:
 1FF6Y 200 x 5.7/3.7 x 5 x 64 x R 1.9
 D126 MB02 C25



Metal bonded grinding wheels

100GRG

D/D1 x T x X x R x V°

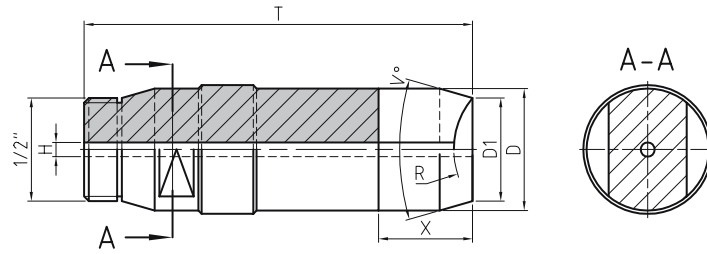

D	D1	T	X	R	V°
26	22	83	20	17	40

100GRF

D/D1 x T x X x R x V°

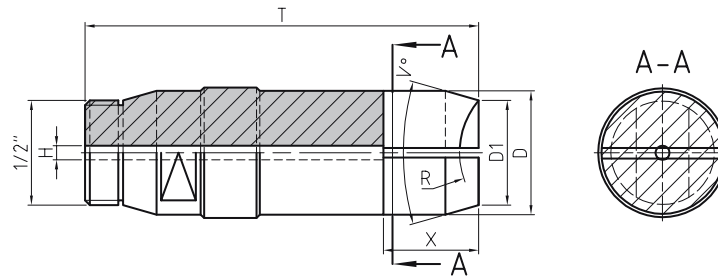

D	D1	T	X	R	V°
26	22	83	20	17	40
27	22	83	20	17.1	40

Order printout sample:
 100GRF 26/22 x 83 x 20 x R17 x V40
 D181 MB17 C60



Metal bonded grinding wheels

1A1R

D x U x X x H

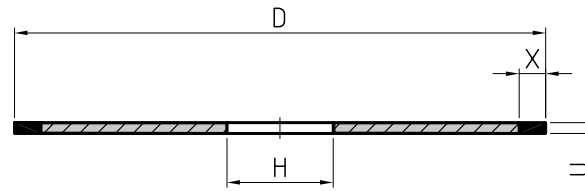

D	U	X	H
100	1.2/15/2	5	Custom-made
115	1.2/15/2	5	
125	1.2/1.5/2	5	
150	1.2/1.5/2	5	
175	1.5/2.2	5	
200	1.5/2.2/2.5	5	
250	2/2.2/3	5	
300	2/2.5/3.2	5	
350	2/3	5	
375	2.2	5	
400	2.5	5	

Order printout sample:
 1A1R 300 x 2 x 5 x 20
 D107 MB01 C30



Metal bonded grinding wheels

14DAD1

D/D₁ x T x U/U₁/U₂ x X x H

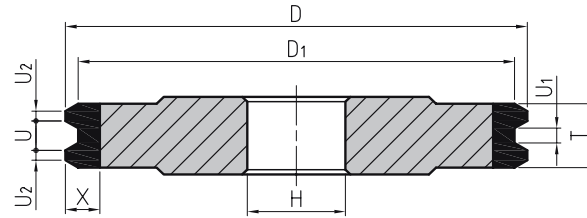

D/D ₁	T	U/U ₁ /U ₂	X	H
175/171	12	6/2/1	5	Custom-made
175/171	12	7/4/1	5	
175/171	14	8/4/1	5	
175/171	16	10/6/1	5	
175/171	20	12/8/1	5	
200/197	14	8/4/1	5	
200/197	16	9/6/2	5	

Order printout sample:
 14DAD1 175/171 x 12 x 6/2/1 x 5 x 64
 D151 MB02 C25



Metal bonded grinding wheels

100G

D x X x L

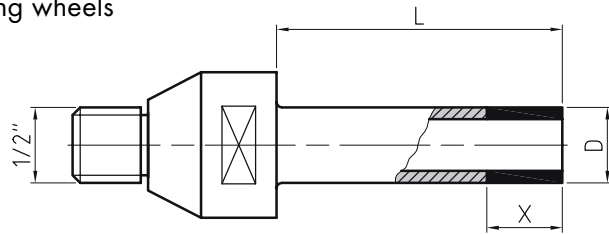

D	X	L
3	10	30
4	10	
5	10	
6.5	10	
7	10	
8	10	
9	10	
11	10	
12	10	
13	10	
14.5	10	
15	10	
16	10	
17	10	
18	10	
19	10	40
20	10	
21	10	
22	10	
23	10	
24	10	

D	X	L
25	10	40
26	10	
27	10	
28	10	
29	10	
30	10	
32	10	
34	10	
35	10	
36	10	
37	10	
38	10	
39	10	
40	10	
41	10	
42	10	
43	10	
44	10	
45	10	
46	10	
48	10	
50	10	
52	10	
53	10	
54	10	
55	10	
56	10	
57	10	
58	10	
60	10	

D	X	L
61	10	40
62	10	
63	10	
64	10	
65	10	
67	10	
68	10	
70	10	
73	10	
75	10	
78	10	
80	10	
83	10	
84	10	
85	10	
90	10	
95	10	
97	10	
98	10	
100	10	
107	10	
109	10	
110	10	
110	10	
120	10	
122	10	
125	10	
127	10	
130	10	
140	10	

Order printout sample:
 100G 15 x 10 x 30
 D151 MB01 C50



Metal bonded grinding wheels

100GG

D/D₁ x X/X₁ x L

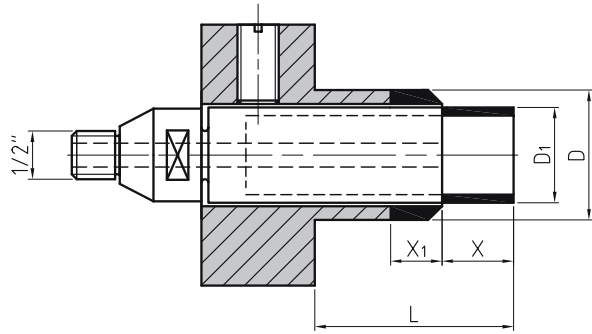

D	D ₁	X	X ₁	L
7	5	5	10	X + X ₁ + 12
8	6	5	10	
9	7	5	10	
10	8	5	10	
11	9	5	10	
11.5	9.5	5	10	
12	10	5	10	
13	6.8	10	8	
13	7	5	10	
15	12	10	5	
17	14.5	11	4	
19	13	10	5	
19.5	13.5	10	5	
21	19	5	3	
23	21	5	3	
24	22	10	5	
25	19	10	6	
26	18	10	5	
26	18	10	10	
33	24	10	3	
42	35	10	5	
42	37	10	5	
42	38	10	5	
45	33	12	10	
45	42	10	10	
45	43	12	10	
45.2	42.6	21.1	18.1	

D	D ₁	X	X ₁	L
47	33	12	10	X + X ₁ + 12
60	56	10	10	
61	57	10	10	
64	59	10	10	
100	96	10	5	
110	104	10	10	
115	110	10	10	
117.5	113.5	10	10	
120	116	10	10	

Order printout sample:
 100GG 7/5 x 5/10 x 30
 D181 MB17 C60



Metal bonded- **E**lectroplated grinding wheels

100G-G

D/D₁ x X/X₁ x L

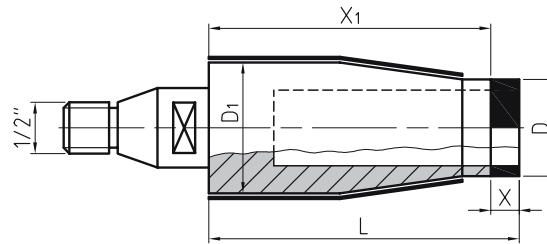

D	D ₁	X	X ₁	L
4	6	10	45	Custom-made
4	7	10	43	
4.5	6	10	45	
4.5	8	10	45	
5	7	10	45	
5	9	10	45	
7	10	10	45	
7	11	10	45	
10	15	10	45	
10	17	10	40	
10	19	10	50	
12	14	10	51	
50	60	10	44	
65	76	10	51	
65	78	10	51	
65	79	10	51	
66	79	10	51	
68	78	10	27	
69	79	10	27	

Order printout sample:
 100G-G 65/79 x 10/59 x 72
 D151 MB01 C50

3

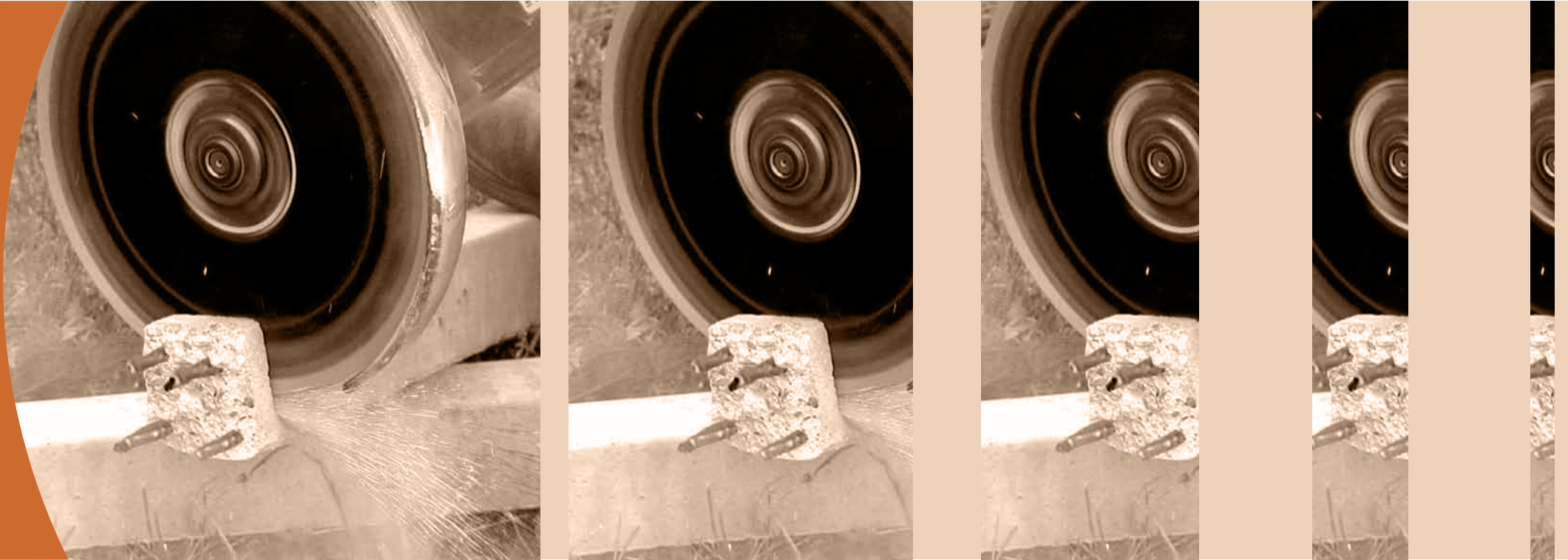



	3.1	Cutting	94-96
	3.2	Cutting out	97
	3.3	Grinding	98
	3.4	Profile grinding	99
 	3.5	Manual cutting-off and grinding	100-101

3.1

CUTTING



Metal bonded saw blades

C1, C1S
C2, C2-S
C3
 D x X x H

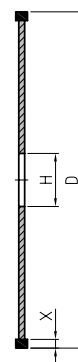
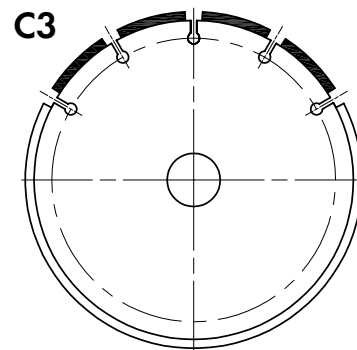
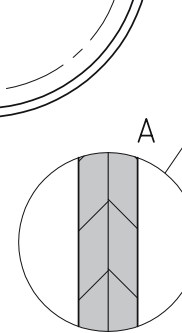
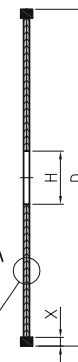
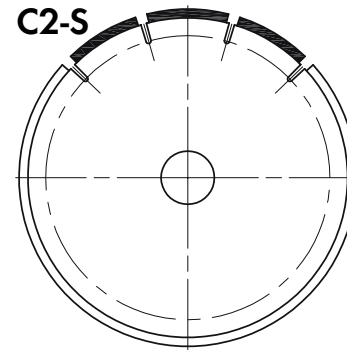
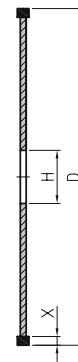
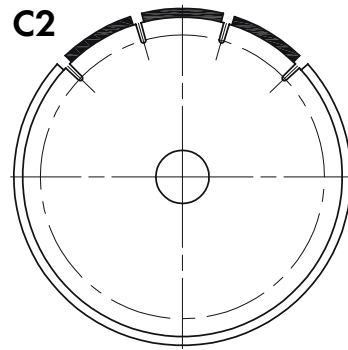
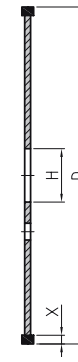
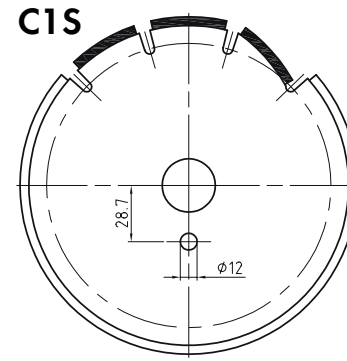
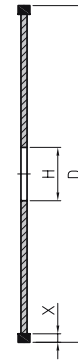
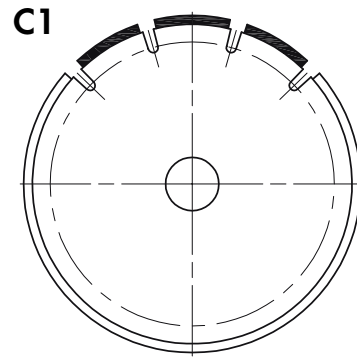

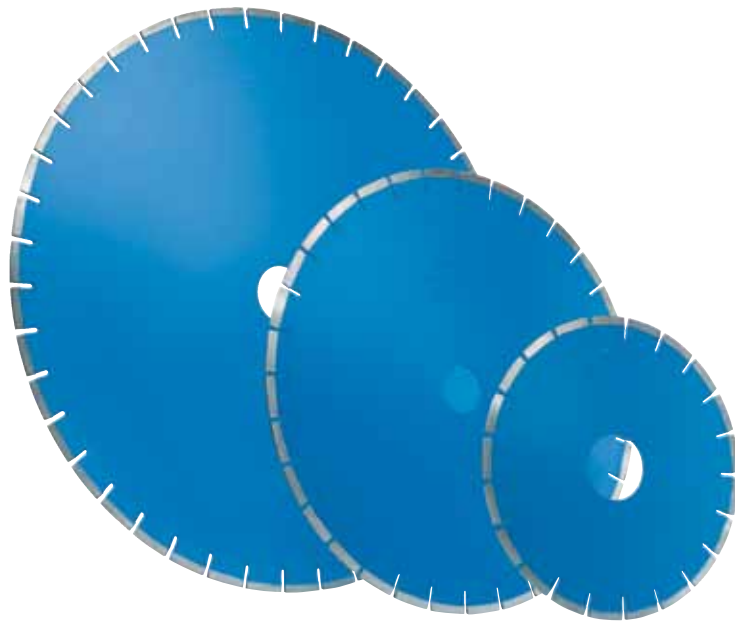

Order printout sample:
Saw blade C1 - concrete
300 x 10 x 30

WORKPIECE	CUTTING TOOL SHAPE
Concrete	C1, C2, C3
Reinforced concrete	C1, C2
Asphalt	C1S
Fire clay	C1S
Marble	C2, C2-S
Granite	C2, C2-S

D	C1	C1S	C2	C2-S	C3	X	H
300	•	•	•	•	•	10	Custom-made
350	•	•	•	•	•		
400	•	•	•	•	•		
450	•	•	•	•	•		
500	•	•	•	•	•		
550	•	•	•	•			
600	•	•	•	•			
625	•		•	•			
650	•		•	•			
700	•		•	•			
750	•		•	•			
800	•		•	•			
850	•		•	•			
900	•		•	•			
1000	•		•	•			
1100			•	•			
1200	•		•				
1300			•				
1600	•						



Metal bonded grinding wheels

SEGMENT

L x X x T

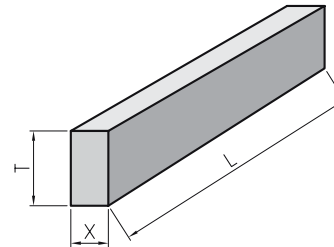

L	X	T
24	3.2-10.0	10
40	3.2-10.0	10

Metal bonded grinding wheels

DIAMOND WIRE

L x D

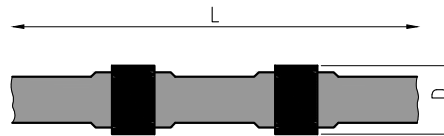

L m	D mm
5.2	8.8/10.5/11
5.7	8.8/10.5/11
18	8.8/10.5/11
20	8.8/10.5/11

Order printout sample:
Wire - granite
5.2 x 8.8





3.2

CUTTING-OUT



Metal bonded grinding wheels

DK - concrete

D x T x H

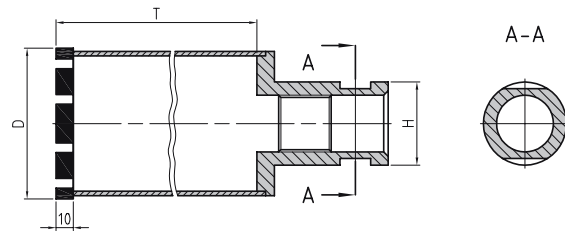

D	T	H
19	300-500	R1/2 or M31.7mm
20/24/28		
31/35/38		
40		
50/52		
60/65		
70/73/75		
80		
90/91/95		

D	T	H
100/105/110/120/130	300-500	R1/2 or M31.7mm
140/150/170/185/186		
220/225/226/250/280		
300/350		
400		
550		
600		

DKS - concrete

D x T

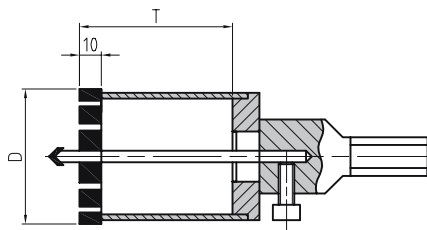

D	T
20/22/25/28	60
30/32/36	
50/52/55	
60/62/65	
82	
90	
120	
130	

Order printout sample:

DKS - concrete

20 x 60



Metal bonded grinding wheels

DP – concrete

D x T₁ x H

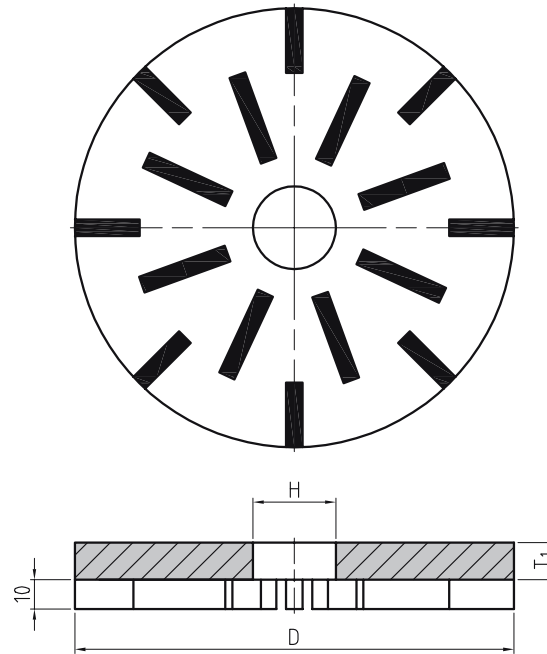

Order printout sample: DP – concrete
200 x 6 x 20

D	T ₁	H
200	3.7/6	Custom-made



3.4

PROFILE GRINDING



Vacuum brazed grinding wheels

FR-VB/1 - stone

D x R x M

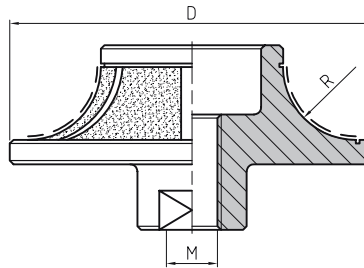

D	R	M
100	10	M14

FR-VB/1 - stone

D x U x H

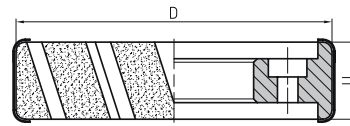
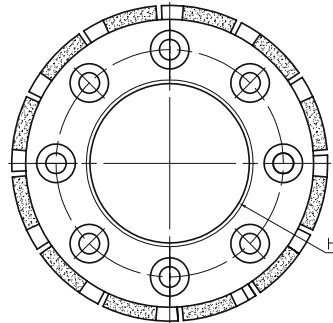

D	U	H
86	21	50

FR-VB/3 - stone

D x T x H

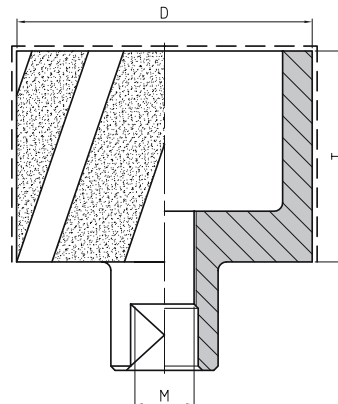

D	T	H
70	50	M14
70	50	22.22

Order printout sample:
 FR-VB/3 - stone
 70 x 50 x M14

Metal bonded saw blades
UNIVERSAL Professional

Segment shape	Specification	Workpiece	Quality class	
Segment with protection	Directly sintered segment	Concrete, reinforced concrete, roof tiles, asphalt, fire clay and other abrasive materials	Professional	
Shape	Dimensions D x X x H	Peripheral speed (m/s)	RPM 1/min	Packaging unit Piece
C1S	115 x 7 x 22.2	80	13300	1
	230 x 7 x 22.2	80	6650	1

SEGMENT Standard

Segment	Specification	Workpiece	Quality class	
Segment with protection	Laser welded segment	Sleek concrete, screed, asphalt, fire clay and other abrasive materials	Standard	
Shape	Dimensions D x X x H	Peripheral speed (m/s)	RPM 1/min	Packaging unit Piece
C3	115 x 10 x 22.2	80	13300	1
	125 x 10 x 22.2	80	12550	1
	230 x 10 x 22.2	80	6650	1

TURBO Professional

Segment shape	Specification	Workpiece	Quality class	
Segment with protection	Directly sintered segment	Granite, marble, fire clay	Professional	
Shape	Dimensions D x X x H	Peripheral speed (m/s)	RPM 1/min	Packaging unit Piece
1A1R - Turbo	115 x 10 x 22.2	80	13300	1
	125 x 10 x 22.2	80	12550	1
	230 x 10 x 22.2	80	6650	1

Order printout sample:
Turbo Professional saw blade
230 x 10 x 22.2

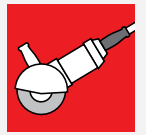

CONTI Standard



Segment shape	Specification	Workpiece	Quality class
Conti ring	Directly sintered segment	Ceramic tiles	Standard

Shape	Dimensions D x X x H	Peripheral speed (m/s)	RPM 1/min	Packaging unit Piece
1A1R	115 x 10 x 22.2	80	13300	1
	125 x 10 x 22.2	80	12550	1
	230 x 10 x 22.2	80	6650	1

GRINDING CUPS Professional



Order printout sample:
Professional grinding cup
125 x 22.2

MANUAL GRINDING



Segment shape	Specification	Material	Quality class
Segment	Laser welded segment	Concrete and granite	Professional

Shape	Dimensions D x H	Peripheral speed (m/s)	RPM 1/min	Packaging unit Piece
RR8	100 x 22.2	80	13300	1
	110 x 22.2	80	13900	
	115 x 22.2	80	13300	
	125 x 22.2	80	12250	
	150 x 22.2	80	10200	
	180 x 20	80	8500	
	180 x 22.2	80	8500	

4





Metal bonded grinding tools

1A1

D x U x X x H

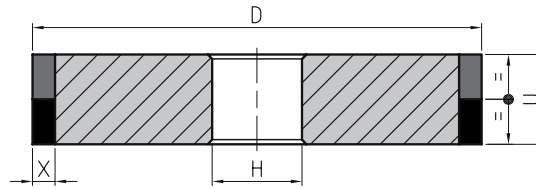

D	U	X	H
60	15	5	Custom-made
75	15	5	
100	15	5	
150	14	5	
200	15	5	
270	50	8	
400	40	8	
420	40	8	
450	150	8	
550	70	8	

6A2

D x W x X x H

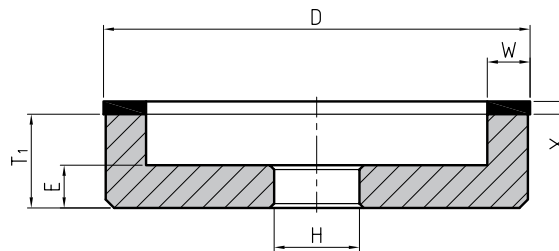

D	W	X	H	T ₁	E
60	15	40	Custom-made	Custom-made	Custom-made
75	15	40			
115	15	50			

Order printout sample:
6A2
60 x 15 x 40 x H

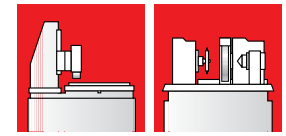

Metal bonded grinding tools

NOSKAL 1

B x C x L x W x X

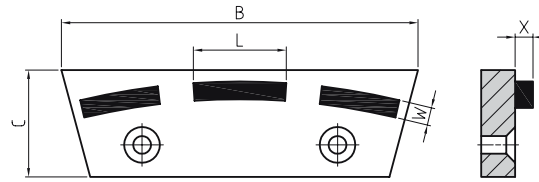

B	C	L	W	X
100	30	24	10.5	7
112	46	40	10	7
150	35	24	10.5	7

NOSKAL 2

A x B x C x L x W x X

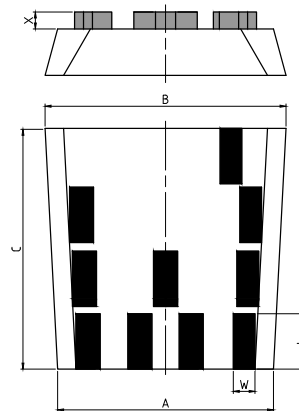
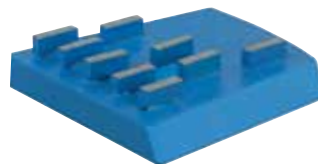

A	B	C	L	W	X
70	80	108	20	10	10
95	101	37.5	20	10	10
80	110	108	24	10	10
80	110	108	24	10	10
85	110	108	24	10	10

Order printout sample:
Noskal 2
85 x 110 x 108 x 24 x 10 x 10

INCORRECT HANDLING

DON'T ever handle the grinding tools roughly.

STORAGE

DON'T ever store the grinding tools in a humid environment or at extreme temperatures.

TOOL SELECTION

DON'T ever use a grinding tool without first checking its intended application.

VISUAL INSPECTION

DON'T ever use a damaged or incorrectly used grinding tool.

MOUNTING

DON'T ever mount a damaged grinding tool.

DON'T use mounting flanges that are inappropriate, damaged, dirty or worn out.

DON'T tighten the mounting flange excessively, as this could damage it.

DON'T exceed the maximum permitted operating circumferential speed.

FURTHER INFORMATION

DON'T ever grind without using a safety guard which must cover at least one half of the grinding tool.

DON'T ever use a machine not in a good mechanical condition or not maintained regularly.

DON'T apply excessive force to grinding tools as this may slow down the machine.

DON'T ever use a machine without an appropriate dust removal system.

DON'T apply side pressure to thin grinding wheels.

DON'T stop the grinding tool after use by applying pressure to the tool edge or side. Always switch the machine off and allow the tool to stop revolving.

DON'T use the machine in a position where you do not have full control of its operation.



CORRECT HANDLING

DO always handle the grinding tools with extreme caution, especially those which have already been used.

STORAGE

DO always protect the grinding tools from mechanical damage and adverse environmental influences during storage.

TOOL SELECTION

DO always follow the information on the label or tool when selecting a grinding tool, as well as the information on the limitations of use from the catalogue.

DO always request additional information from the manufacturer or supplier when in doubt concerning tool selection.

VISUAL INSPECTION

DO always visually inspect grinding tools before mounting and eliminate damaged ones.

MOUNTING

DO always mount the grinding tool onto the machine in accordance with the tool and machine manufacturer's instructions.

DO always use the original tools supplied by the machine manufacturer to change the grinding tool.

DO always use correct mounting flanges for grinding tools and check that they are undamaged and free of burrs.

DO always check to see that the workpiece is firmly secured before beginning grinding.

DO always run newly mounted grinding tools at the maximum operating speed first, then reduce the rpm to the operating speed and allow the tool to run at least 60 seconds before you begin grinding.

FURTHER INFORMATION

DO always install a safety guard on the machine before grinding.

DO regularly check the operating speed of the machine, and always after maintenance and repairs.

DO always check the driving belt tension to achieve optimum power transmission.

DO always wear personal protective gear, depending on the machine type and application: protective wear for the eyes and face, protective footwear, gloves, ear protection, respiratory protection and other safety gear.

DO always use the grinding tools for the applications they were designed for.

DO always place the machine in an appropriate place where there is no possibility of mechanical damage.

DO always keep the workplace tidy to prevent slips or falls during grinding operations.



Grinding tools are sensitive to atmospheric influences and impacts which cause cracks that are invisible to the human eye but may cause the tool to break when the machine is started. Grinding tools must be stored well-protected, preferably in the original packaging. The storage area should not be damp and the temperature not below freezing.

The lifespan of resin and hybrid bonded grinding wheels is three years from the date of manufacture. Vitrified, metal and electroplated grinding wheels do not have limited durability if stored properly. **All grinding wheels have a 3-year warranty.**

Even though the packaging protects the product during transport, the boxes or crates should be moved carefully. After admission to the warehouse and prior to mounting the grinding wheel on the grinding machine, be sure to make a visual inspection.

If the grinding wheel is inadequate, consult the manufacturer about its suitability for use prior to mounting.





SWATYCOMET, umetni brusi in nekovine, d.o.o.
Titova cesta 60, 2000 Maribor, Slovenia
t: +386 (0)2 3331 600, (0)3 7575 000
f: +386 (0)2 3331 790, (0)3 7575 100
www.swatycomet.si, e: info@swatycomet.si



Toroflex Schleifmittel, GmbH
Esbachgraben 17, 95463 Bindlach – Niemcy



Ecopack, d.o.o.
Tovarniška 5, 3214 Zreče – Slowenia

