

SWATY COMET



Industrial Grinding Tools

VITRIFIED AND RESIN BONDED





2015 Catalogue



SWATYCOMET



CONTENTS Page

	Types of grinding wheels and dimensions	6 - 11
	Marking of material properties and grinding wheels	12 - 20
	Use of grinding tools	21 - 26
	Diamond dressing tools and coolants	27 - 35
	Selection of grinding wheel types, dimensions, materials and ordering	36 - 37
01	PERIPHERAL SURFACE GRINDING	38 - 41
02	SURFACE GRINDING WITH SEGMENTS, RINGS AND CUPS	42, 45
03	EXTERNAL CYLINDRICAL GRINDING	46, 47
04	CENTERLESS EXTERNAL CYLINDRICAL GRINDING	48, 49
05	GRINDING OF THREADS AND GEARS	50-53
06	INTERNAL CYLINDRICAL GRINDING	54-55
07	TOOL GRINDING AND SHARPENING	56-60
08	MANUAL GRINDING ON STATIONARY MACHINES	61
09	MOUNTED POINTS	62 - 67
10	FILES	68 - 73
11	 SPRING END GRINDING	74, 75
12	 ROLL GRINDING	76 - 79
13	 FOUNDRY GRINDING WHEELS	80 - 87
14	GRINDING WHEELS FOR STEEL INDUSTRY	88 - 91
15	 RAILWAY GRINDING AND CUTTING	92 - 97
16	GRINDING CUPS	98, 99



SWATYCOMET was founded in 2010 and represents the merger of two reputed companies with their own individual rich traditions, i.e. over 130 years of SWATY of Maribor and over 50 years of COMET of Zreče.



Grinding belongs among those cutting procedures in which the tool has many cutting edges that are irregular in shape and act as turning knives during grinding. Grinding is performed at very high speeds, up to 125 m/s.

It can be divided into coarse, fine, honing and finishing. The following effects can be achieved:

- High material removal rates
- High dimensional accuracy
- Very smooth surfaces
- Ability to work very hard materials

The main motion involved is tool rotation.

With regard to the type and feed of workpiece and tool motion, grinding is divided into:

- High material removal rates
- Cylindrical grinding
- Surface grinding
- Tool sharpening

Grinding tools are bonded abrasives. The quality and applicability of an abrasive depend on the quality and the specification ratios of abrasive grit, the bonding material and pores. The specification of an abrasive is determined by:

- Abrasive grit quality
- Abrasive grit size
- Hardness
- Structure
- Bonding material



FINE GRINDING:

- Peripheral surface grinding
- Surface grinding with grinding segments, rings and cups
- Double disc surface grinding
- Springs grinding
- External cylindrical grinding
- Centerless external cylindrical grinding
- Flute grinding
- Internal cylindrical grinding
- Tool grinding and sharpening
- Gear grinding
- Manual grinding on stationary grinding machines
- Manual grinding with mounted points
- Cutting
- Honing.

COARSE GRINDING:

- Grinding wheels for snagging
- Hot pressed snagging wheels
- Cutting with reinforced wheels

APPLICATIONS:

- Steel plants
- Foundries
- Shipbuilding
- Automotive industry
- Toolmaking
- Civil engineering and construction
- Agriculture
- Food industry
- Glassmaking
- Stonecutting
- Arts and crafts.

GRINDING WHEEL TYPES (according to ISO 525)

1 D_xT_xH Pages 39, 40, 46, 48, 57, 61, 77

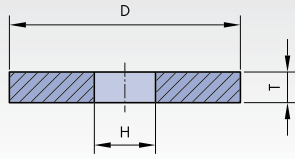

1A D_xT_xH Pages 83, 84, 85, 93

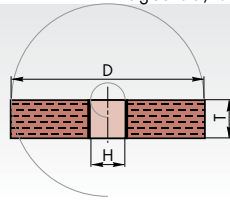

1VS, 1FK D_xT_xH Pages 85, 89

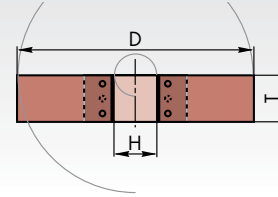

1Z D_xT_xH-M Page 51

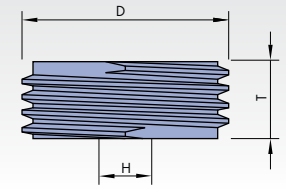

1A1 D_xT_xX_xH Pages 39, 55

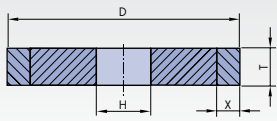

1A8, 1 NA D_xT_xH Pages 54, 55, 50

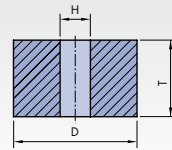

1A8, 5NB D_xT_xH-P_xF Pages 54, 55

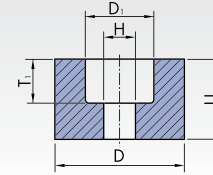

2 D_xT-W Page 44

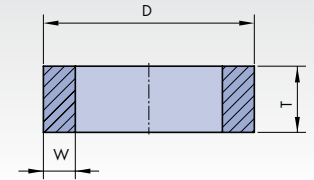

3, 3K1 D/J_xT/U_xH Pages 58, 53

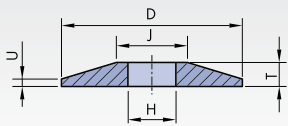

3K, 3K2 D/J_xT/U_xH-V.. Page 53

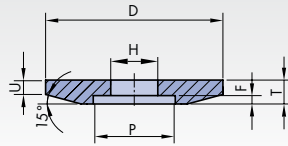

4, 4N D/J_xT/U_xH_xV.. Pages 52, 58

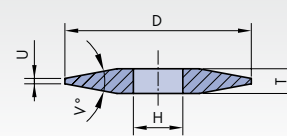

5 D_xT_xH-P_xF Pages 40, 46, 48, 59, 77, 93

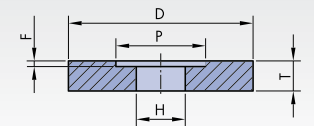

6 D_xT_xH-W..E.. Pages 44, 59

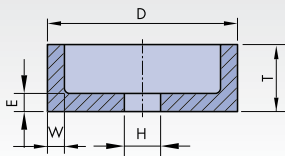

7 D_xT_xH-P_xF/G Pages 40, 47, 49, 77, 93

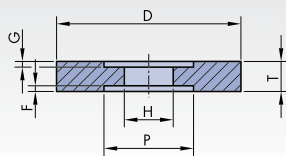

7Y2 D_xT_xH-P_xF Page 96

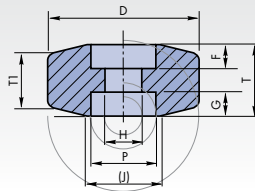

9 D_xT_xH-W..F..G.. Page 40

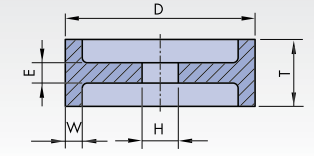

11 D/J_xT_xH-W..E..K.. Page 60

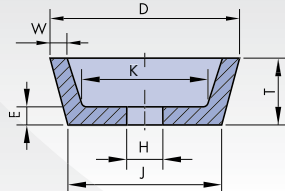

12 D/J_xT/U_xH-W..E..K..V.. Page 58

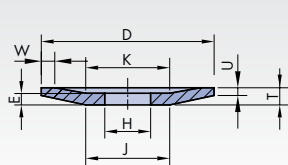

12B D/J_xT/U_xH-W..E..K..V.. Page 59

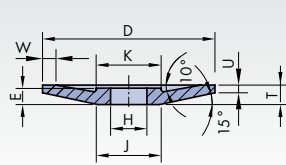

12BH D/J_xT/U_xH-W_xExK-V..

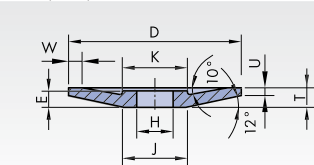

12M D/J/kxT/UxH Pages 40,52

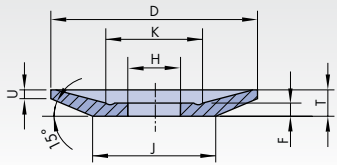

20 D/KxT/NxH

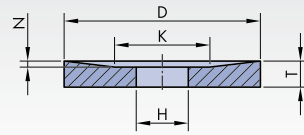

21 D/KxT/NxH

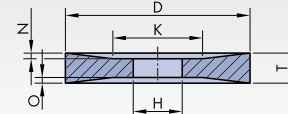

21P D/KxT/NxH

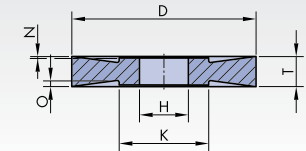

22 D/KxT/NxH-PxF

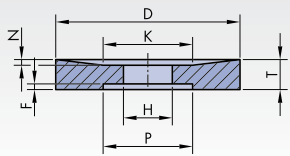

23 DxT/NxH-PxF

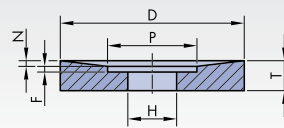

24 DxT/NxH-PxF/G

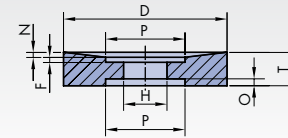

25 D/KxT/NxH-PxF

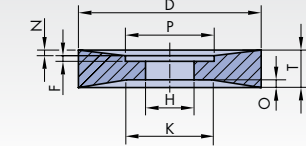

26 DxT/NxH-PxF/G

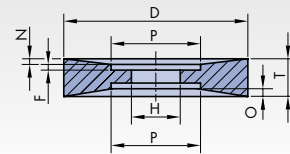

27 DxUxH Page 82

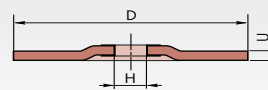

28 DxUxH Page 82

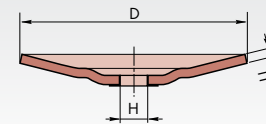

35 D/JxTxH Pages 75, 86, 95

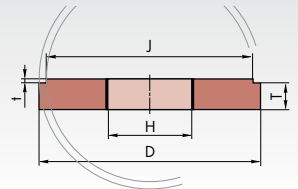

36 DxTxH-M Pages 75, 79, 86, 96

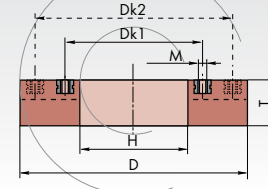

36P DxTxH-M Page 75

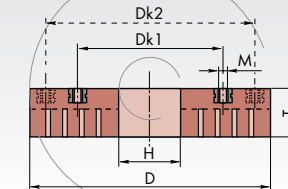

37 DxTxH-M

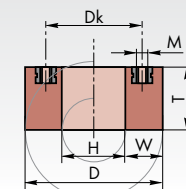

38 D/JxT/UxH

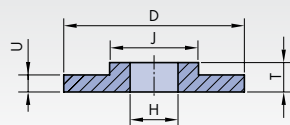

39 D/JxT/UxH

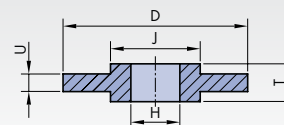

41 DxTxH Pages 40, 90, 97

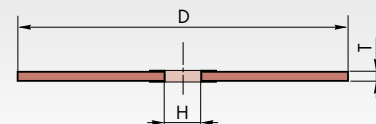

42 DxUxH Page 91

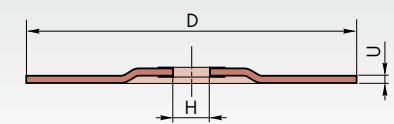

GRINDING SEGMENT TYPES

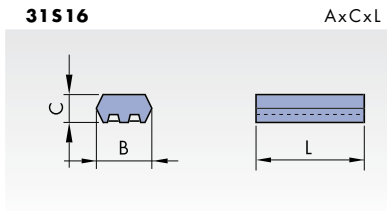
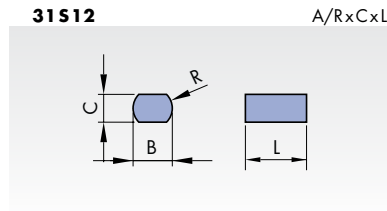
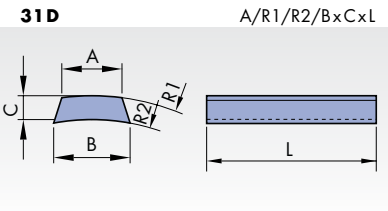
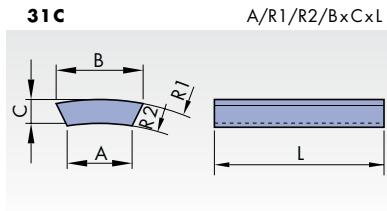
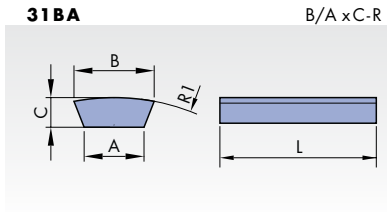
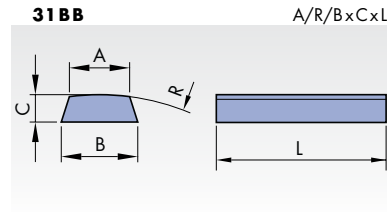
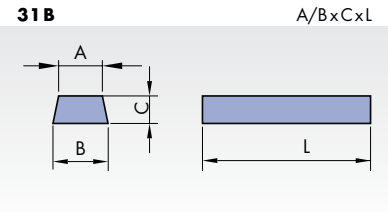
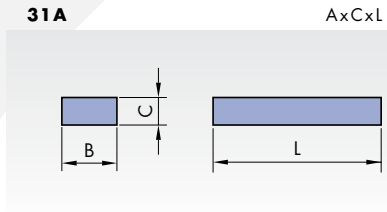

FILE TYPES

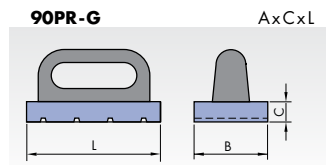
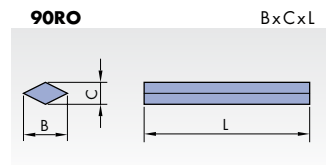
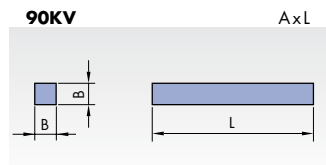
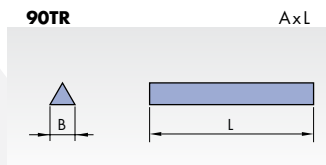
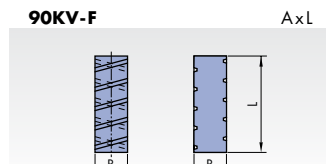
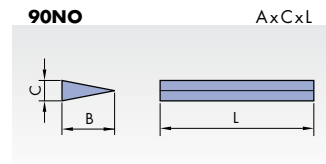
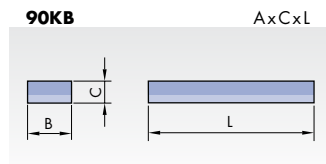
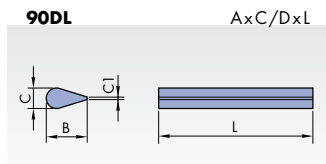
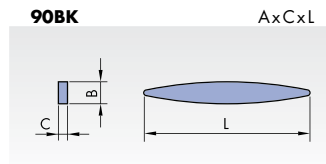
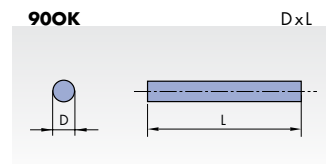
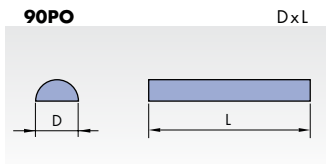
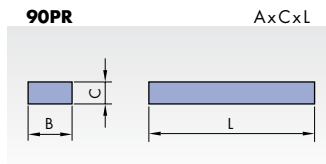



MOUNTED POINT TYPES

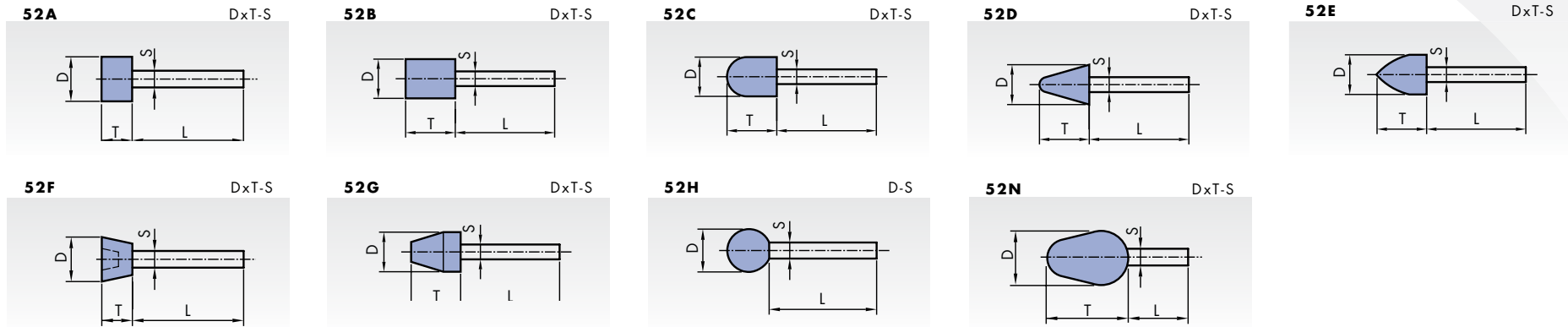

MOUNTED POINT TYPES WITH NUTS

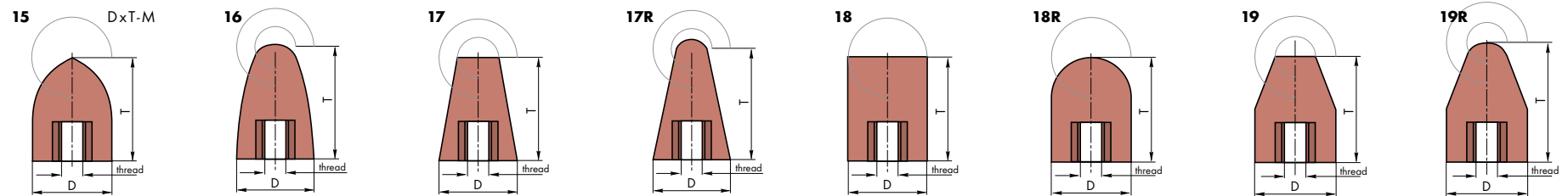

GRINDING CUP TYPES

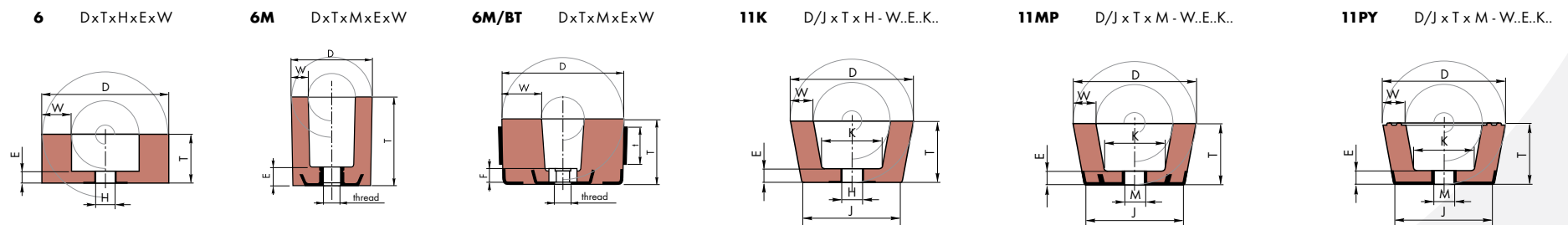

STANDARD GRINDING WHEEL DIMENSIONS in mm and inches

Grinding wheel diameters (D):

D/mm	inches
* 3	1/8
* 4	5/32
* 5	3/16
* 6	1/4
* 8	5/16
* 10	3/8
* 13	1/2
* 16	5/8
* 20	3/4
* 25	1
30	13/16
* 32	11/4
* 40	11/2
* 50	
51	2
* 63	21/2
75	
76	3
* 80	
82	31/4
* 100	
102	4
* 115	41/2
* 125	
127	5
* 150	
152	6
* 175	
178	7
* 180	
* 200	
203	8
* 225	

D/mm	inches
* 230	
* 250	
254	10
* 300	
305	12
* 350	
356	14
* 400	
406	16
* 450	
457	18
* 500	
508	20
* 600	
610	24
650	
660	26
700	
710	28
* 750	
762	30
* 800	
813	32
* 900	
914	36
* 1000	
1016	40
* 1060	
1067	42
1100	
1118	44
* 1250	

*DIN standard 603-1 through 603-12



Grinding wheel thicknesses (T):

T/mm	inches	
*	0.5	
*	0.6	
*	0.8	
	1	
*	1,2	3/64
*	1,6	1/16
*	2	5/64
*	2.5	3/32
	3	1/8
*	3,2	
	3,5	9/64
*	4	5/32
*	5	3/16
*	6	
	6,4	1/4
	7	
*	8	5/16
	9,5	3/8
*	10	
	12,7	1/2
*	13	
*	16	5/8
*	20	
	21	13/16
*	25	1
*	32	11/4

T/mm	inches	
	38	11/2
*	40	
*	50	
	51	2
*	63	
	64	21/2
	76	3
*	80	
*	100	
*	102	4
*	125	
	127	5
	150	
	152	6
*	160	
*	200	
	203	8
*	250	
**	254	10
	300	
	305	12
*	315	
*	400	
	406	16
*	500	
	508	

** Grinding wheels with thicknesses of over 300 mm are composed of two or more parts.

Grinding wheel hole diameters (H):

H/mm	inches	
*	1,6	1/16
*	2,5	3/32
*	4	5/32
*	6	
	6.4	1/4
*	8	
	9,5	3/8
*	10	
	12.7	1/2
*	13	
	15,9	5/8
*	16	
	19,1	3/4
*	20	
*	22,2	7/8
*	25	
	25,4	1
	31,8	11/4
*	32	
	38,1	11/2
	40	
*	50,8	2
*	(51)	
	60	
*	(76)	
	76,2	3
*	80	
*	100	
*	127	5
*	152,4	6
*	160	
	(203)	
*	203,2	8
*	250	
	254	10
*	304,8	12
	(305)	
*	406.4	16
*	508	20

* DIN standard 603-1 through 603-12

42A	120/9	H		7/5			V	R12L	63 m/s
Grain type and combination	Grit size and grit size combinations	Hardness	Hardness	Structure /	Porosity	Bond	Internal designation	Maximum operating speed	
1A	8	Coarse	D	Soft	1	Closed	1	V - Vitrified B - Resin BF - Fibre-reinforced resin	
3A	10		E		2		2		
A	12		F		3		3		
2A	14		G		4		4		
	16		H		5		5		
	20		I		6				
	24		J		7				
	30		K		8				
7A	36		L		9			R - Laterally reinforced E - Unilaterally surface reinforced D - Bilaterally surface reinforced	
4A	40		M		10				
6A	46		N		11				
PA	54		O		12				
	60		P		13			W - Impregnated	
8A	70		Q		14				
GA	80		R		15				
LA	90		S		16				
9C	100		T	Hard	17				
C	120				18				
	150				19				
ZA	180				20	Open			
	220								
	240								
	280								
	320								
	360								
	400								
	500								
	600								
	800	Fine							



SPECIFICATION OF SUPERABRASIVES

02B	126	P	4	V	C100
Abrasive grain quality	Abrasive grit size	Hardness	Structure/Porosity	Bond	Concentration
02B	427 Coarse	J Soft	3 Closed	V - Vitrified	50
03B	301	K	4	B - Resin	75
05B	252	L	5		100
06B	181	M	6		125
01D	151	N	7 Open		150
121B	126	O			175
	107	P			
	91	R Hard			
	76				
	64				
	54				
	46 Fine				

ABRASIVE GRAIN QUALITY

In the manufacture of vitrified bonded grinding wheels, we use SiC and Al-oxide abrasive grain and various grit mixtures.

ABRASIVE GRAIN AND ITS PROPERTIES

Hardness		Toughness	
GA	Al-oxide, special ceramic	GA	Al-oxide, special ceramic
8A	Al-oxide, special monocrystalline	ZA	Corundum, zirconium
2A	Al-oxide, pure white	5A	Al-oxide, special Mg
PA	Al-oxide, special "dirty pink"	MA	Al-oxide, normal blue
6A	Al-oxide, special ruby	A, 3A	Al-oxide, normal
4A	Al-oxide, pure pink	7A	Al-oxide, semi-pure
7A	Al-oxide, semi-pure	8A	Al-oxide, special monocrystalline
MA	Al-oxide, normal blue	PA	Al-oxide, special "dirty pink"
A,3A	Al-oxide, normal	4A	Al-oxide, pure pink
LA	Al-oxide, special	6A	Al-oxide, special ruby
ZA	Corundum, zirconium	2A	Al-oxide, pure white
C	Silicon carbide, green	LA	Al-oxide, pure white
9C	Silicon carbide, black	9C	Silicon carbide, black
		C	Silicon carbide, green

PROPERTIES OF DIAMOND AND CBN GRAIN

PROPERTY	Unit	Diamond	CBN
Density	g/cm ³	3.52	3.48
Hardness (Knoop)	kg/mm ²	7000	4700
Hardness (Mohs)	-	10	9/10
Temperature stability	° C	600 - 700	1100 -1400



ABRASIVE GRAIN	Type of grinding, work piece, condition of material		
	TYPE OF GRINDING	GROUND MATERIAL	MATERIAL GRINDING HARDNESS
Aluminium oxide, normal	Coarse grinding, surface grinding	Low-alloy steel, iron materials	Tensile strength between 300 and 500 N/mm ²
Aluminium oxide, semi-pure	Surface grinding, cylindrical grinding, multipurpose	Alloy steel	Tensile strength approx. 500 N/mm ²
Aluminium oxide, pure, white	Surface grinding, external and internal cylindrical grinding, profile grinding	Alloy steel and high-alloy steel	Hardness up to 62 HRc
Aluminium oxide, pure, pink	Tool grinding, saw blade and knife sharpening, profile grinding, gear grinding	Hardened steel, casting	Tensile strength over 500 N/mm ²
Aluminium oxide, special	All types of grinding	Hardened steel, tool steel, high-speed steel	Hardness over 62 HRc
Aluminium oxide, vitrified GA	All types of grinding	Alloy steel, high-alloy steel, tool steel	Hardness between 58 and 65 HRc, universal applicability
Aluminium oxide special LA	Finishing Universal applicability	All types of steel, alloys	Hardness up to 65 HRc
Corundum zirconium (only resin bonded)	Universal applicability	Alloys, low-alloy steel, tool steel, gray alloy, nodular alloy	
Silicon carbide, green	All types of grinding	Tungsten carbides, gray alloy, non-ferrous metals, plastic materials, nitriding steel, acid resistant steel	
Silicon carbide, black	All types of grinding	Gray alloy, plastic materials, non-ferrous metals, ceramics, glass	
CBN	All types of grinding	Steel	Hardness over 50 HRc
Diamond	All types of grinding	Hard metal alloys, ceramics	



Abrasive grain size complies with international standards and requirements.

It is designated with numbers according to the FEPA standard. The number indicates the number of holes per inch length (25.4 mm) in a wire sieve that permits the grit to pass through. Macro grits have a granulation up to 200, and micro grits have a granulation of over 240.

FEPA	Dimensions (mm)	
8	2,83 - 2,00	Very Coarse
10	2,38 - 1,68	
12	2,00 - 1,41	
14	1,68 - 1,19	Coarse
16	1,41 - 1,00	
20	1,19 - 0,84	
24	0,84 - 0,60	
30	0,71 - 0,50	Medium
36	0,60 - 0,50	
40	0,50 - 0,40	
46	0,40 - 0,30	
54	0,35 - 0,25	
60	0,30 - 0,21	Fine
70	0,25 - 0,18	
80	0,21 - 0,15	
90	0,18 - 0,13	
100	0,150 - 0,110	
120	0,130 - 0,090	
150	0,110 - 0,060	Very Fine
180	0,090 - 0,050	
220	0,075 - 0,045	
240	0,047 - 0,043	
280	0,038 - 0,035	
320	0,031 - 0,028	
400	0,018 - 0,016	
500	0,014 - 0,012	
600	0,010 - 0,008	
800	0,008 - 0,006	
1000	0,005 - 0,004	
1200	0,004 - 0,003	

	FEPA	ASTM E 11 70 (Mesh)	Dimensions (mm)
Coarse	427	40/50	0,425-0,300
	301	40/60	0,300-0,250
Medium	252	40/80	0,250-0,180
	181	80/100	0,180-0,150
	151	100/120	0,150-0,125
	126	120/140	0,125-0,106
Fine	107	140/170	0,106-0,090
	91	170/200	0,090-0,075
	76	200/230	0,075-0,063
	64	230/270	0,063-0,053
	54	270/325	0,053-0,045
	46	235/400	0,045-0,038

The abrasive granulation determines the grinding effect and the quality of machined surface. It is most cost-effective to select the coarsest granulation that still yields the required quality of machining.

When higher material removal rates are required, a combination of coarse grinding and finishing is cost-effective. When a vitrified bonded grinding wheel with CBN and diamond grit is used instead of a conventional one, a considerably finer granulation has to be used to achieve the same surface quality (Al-oxide 100 replaces B76). In addition to granulations according to the FEPA standard, the comparative table below also states values according to the US ASTM standard and grit size in mm.

Coarse grit is intended for coarse grinding, in which large material removal rates are required, while finer grit is intended for achieving smooth surfaces and for small material removal rates.

	Coarse	Medium	Fine	Very Fine
STANDARD	20 - 36	46 - 80	90 - 220	240 - 600
SUPERABRASIVE	427 - 252	181 - 91	76 - 54	46





ROUGHNESS OF GROUND SURFACE

Roughness of the ground surface in grinding with conventional grinding wheels with **SiC and Al-oxide grain**:

Roughness							Grit size										
Ra(μm)	CLA (μ")	Rt (μm)	Rz (μm)	French designation	Russian designation	Grade	36	46	60	80	120	180	320	500			
1,6	63			15	Δ7	N7									Coarse grinding		
1,5	60																
1,25	50	10	6														
1	40																
0,80	32			14	Δ8	N6									Medium fine grinding		
0,63	25	5	3														
0,50	20	4	2,5														
0,45	18	3,5	2,25														
0,40	16	3	2	13	Δ9	N5									Medium fine grinding		
0,35	14		1,36														
0,32	12,5																
0,30	12	2,5	1,6														
0,25	10	2	1,2												Medium fine grinding		
0,20	8	1,6	1	12	Δ10	N4											
0,18	7,2																
0,16	6,3	1,3	0,85														
0,14	5,6																
0,125	5	1,05	0,6												Fine grinding		
0,10	4	0,9	0,5	11	Δ11	N3											
0,09	3,6																
0,08	3,2	0,8	0,4														
0,063	2,5	0,63	0,32														
0,06	2,4	0,6	0,3												Fine grinding		
0,05	2	0,5	0,25	10	Δ12	N2											
0,04	1,6	0,4	0,20														
0,032	1,25																
0,03	1,2	0,3	0,15														
0,025	1	0,25	0,12	9	Δ13	N1									Polishing		
0,02	0,8	0,2	0,1														
0,016	0,63	0,16	0,08														
0,012	0,50	0,12	0,06														
0,01	0,40	0,1	0,05														

Roughness of ground surface after grinding with superabrasives wheels with **CBN and diamond grain**:

Grit size acc. to FEPA		Medium profile deviations	Surface quality	Grinding method
Diamond	CBN	Ra (micron)	Grade	
	B181	1,12	N7 - N6	Very Coarse
	B151	0,75	N6	
	B126	0,66	N6	
D181	B107	0,53	N6 - N5	
D151	B91	0,50	N6 - N5	Medium Fine
D126	B79	0,50	N6 - N5	
D107	B64	0,40	N5	
D91	B54	0,33	N5 - N4	
D79	B46	0,25	N5 - N4	Medium Fine
D64	B35	0,18	N4	
D54		0,16	N4 - N3	
D46		0,15	N4 - N3	Polishing
Micron sizes			N3 - N2	

Ra Mean profile deviations

Rz Mean height of uneven surfaces

N Degree of roughness

HARDNESS

Hardness is the resistance with which the bond prevents break-out of abrasive grains from the bond matrix. Degrees of hardness are designated with letters of the Latin alphabet. Hardness depends on the type and amount of the binding agent, grinding wheel structure and method of grinding wheel production.

A general rule for determining abrasive hardness is that grinding of harder materials requires a softer grinding tools and vice versa.

It is also a rule that smaller contact surfaces between the workpiece and grinding tool require a slightly harder grinding tool and vice versa: larger contact surfaces require a slightly softer, more porous grinding tool.

It is possible to determine the approximate hardness of bonded conventional abrasives for general grinding of steels of specific hardness.

Designation					HARDNESS
D	E	F	G		Very soft
H	I	J	K		Soft
L	M	N	O		Medium
P	Q	R	S		Hard
T	U	V	Z		Very Hard

Hardness	Material hardness			
	do 42 HRc	42 do 50 HRc	50 do 57 HRc	nad 57 HRc
G				X
H				X
I			X	
J		X		
K	X			

When selecting specification, the grinding tool hardness should be:

- reduced by one to two hardness degrees at high material removal rates or when workpiece overheating needs to be prevented.
- increased by one to two hardness degrees when longer grinding tool life is a priority.

In the case of thinner grinding wheels, finer grit of higher hardness should be selected.



STRUCTURE

The structure of a grinding tool determines the ratio of tool volume to abrasive grit volume.

A normal structure is designated with numbers from 1 to 9, while an artificially created porous structure is designated from 10 to 20. The following needs to be designated for structures 11 to 20:

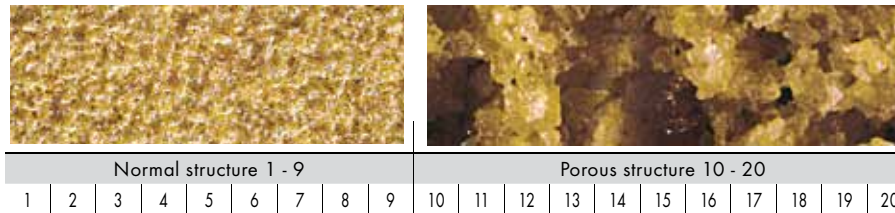

High-porosity grinding wheels provide the most favorable grinding procedure: self-sharpening, cold cutting, better chip removal, smaller force.

GRINDING WHEEL BOND

The purpose of a bond is to bind abrasive grit and thus create the grinding wheel shape. The hardness, structure and grinding properties of grinding wheels depend on the type and amount of the bond.

A vitrified bond is a bond based on clay, kaolin and other materials/fillers. It is thermally treated at temperatures between 900 and 1300 °C. In case of vitrified bonded grinding wheels, the range of hardness values is very broad.

The vitrified bond is sensitive to quick temperature changes and impacts, while various chemicals and duration of storage do not affect them. Normally, vitrified bonded grinding wheels are used at operating speeds of up to 40 m/s; they maintain their shape very well and can be used for all grinding applications (from very coarse grinding to the finest types of grinding).

A resin bond is an organic bond based on phenole formaldehyde resins and fillers. It is obtained by condensation of phenole and formaldehyde with an addition of hexa, and for some types also with a modifier such as epoxy or caoutchouc. It gives the grinding wheel excellent mechanical properties and allows high peripheral speeds.

It is also appropriate for reinforcement (using knitted glass fibres) in order to improve the mechanical properties of the grinding wheels. Compared to the vitrified bond, it is much less sensitive to quick temperature changes and impact, but more so to chemical influences and prolonged storage.

Reinforced resin bond is a variant of resin bond in which fibrous additives are used (usually glass fibres in the form of fabric). Since such bond is reinforced, the product's hardness increases considerably, so it can be used at higher peripheral speeds and side loads.

CONCENTRATION OF SUPERABRASIVE GRAIN

Concentration indicates the amount of superabrasive grain in a grinding wheel. For example, a concentration of 100 means 4.4 carat of grit per 1 cm³ of grinding wheel volume. The 100 concentration is the one that is most commonly used. The concentrations suitable for internal grinding range between 100 and 200. Increasing of superabrasive grit concentration in a grinding wheel also increases its grinding capacity, stability and productivity.

Concentration	CBN and diamond grain		
	Carat/cm ³	g/cm ³	Vol (%)
50	2.2	0.44	12.5
75	3.3	0.66	18.8
100	4.4	0.88	25
125	5.5	1.10	31.3
150	6.6	1.32	37.5
175	7.7	1.54	43.8
200	8.8	1.76	50

CORE MATERIAL

Core material of vitrified bonded grinding wheels with CBN and diamond grain:

Core material	Designation
Vitrified bonded	/
Sintered aluminium	S
Aluminium alloy	A
Steel	J



Responsibility for safety during grinding:

Grinding machine manufacturer

The machine manufacturer must ensure machine stability, strength of the protective housing, as well as the possibility of setting machine strokes and displacements to enable the desired grinding precision, and should also attach instructions for precise and safe work.

Grinding tool manufacturer

The tool manufacturer must produce safe grinding wheels and ensure that the ingredients are properly selected, including correct technological manufacturing procedure and the necessary product control:

- safety speed control (increased peripheral speed, sound, cracks)
- quality control (dimensions, hardness, whipping and balance)

The control methods are prescribed in the international standards EN 12413 and EN 13236, FEPA and ISO.

- Manufacturer's name
- Grinding wheel dimensions
- Grinding wheel specification (type and size of abrasive grit, hardness, structure and bond)
- Max. operating speed
- Warnings regarding grinding wheel use

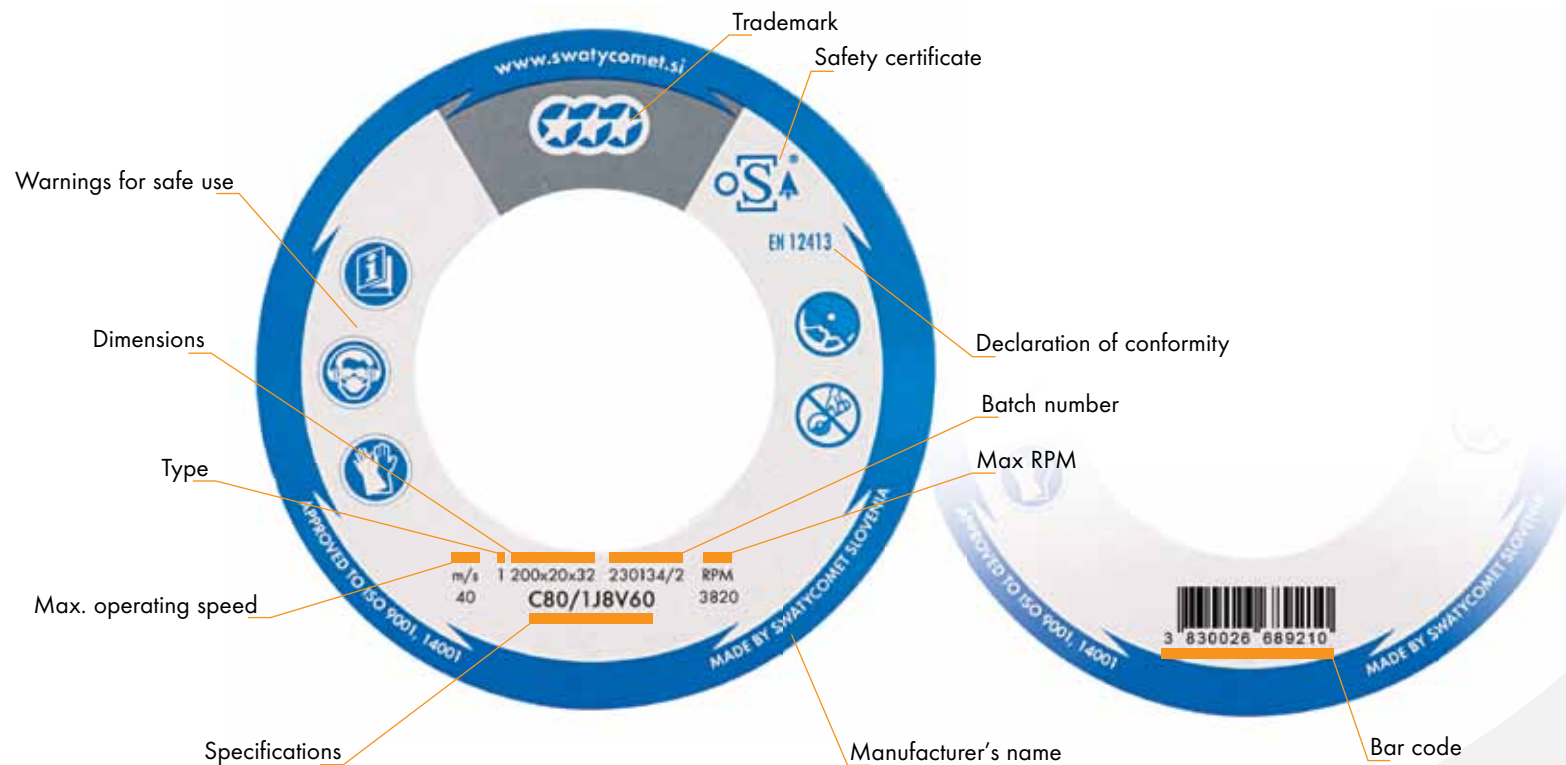

MARKING ON WHEELS

Warnings for safe use



Please read the instructions carefully



Use a safety shield or protective eyewear
Use ear protection
Use a dust mask



Use protective gloves



Free hand grinding or cutting prohibited



Use of damaged products prohibited

Applications (materials)



Steel



Casting



Stainless steel



Hard metals



Colour metals



Plastic material

The data are marked on the product and a cardboard flange (for circular grinding wheels) or on adhesive labels (for noncircular products), which are attached to the product.

Grinding tools without special designations are intended for operating speeds of up to 40 m/s. Grinding wheels for greater operating speeds may be designated with a diagonal color line, as follows:

50 m/s

63 m/s

80 m/s

100 m/s

125 m/s



GRINDING WHEEL OPERATING SPEEDS AND RPM

For individual grinding wheel diameters and operating speeds, the number of revolutions per minute (RPM) is determined from the table below.

D (mm)	Peripheral speed (m/s)												
	12	16	20	25	32	35	40	45	50	63	80	100	125
3	76390	101860	127320	195160	203720	222810							
6	38200	50290	63360	79580	101860	114410	127320	143240	159160	200540	254650		
8	28650	38200	47750	59680	76390	83560	95490	107430	119370	150400	190990	238730	
10	22920	30560	38200	47750	61120	66850	76390	85940	95490	120320	152790	190990	238730
13	17630	23510	29380	36730	47010	51420	58770	66110	73460	92560	117530	146910	183640
16	14320	19100	23870	29840	38200	41780	47750	53710	59680	75200	95490	119340	149210
20	11460	15270	19100	23870	30560	33420	38200	42970	47750	60160	76390	95490	119340
25	9170	12220	15280	19100	24450	26740	30560	34380	38200	48130	61120	76390	95490
32	7160	9550	11940	14920	19100	20890	23870	26860	29840	37600	47750	59680	74600
40	5730	7640	9550	11940	15280	16710	19100	21490	23870	30080	38200	47750	59680
50	4580	6110	7640	9550	12220	13370	15280	17190	19100	24060	30560	38200	47750
63	3640	4850	6060	7580	9700	10610	12130	13640	15160	19100	24250	30320	37890
80	2870	3820	4780	5970	7640	8360	7550	10740	11940	15040	19100	23870	29840
100	2290	3060	3820	4780	6110	6680	7640	8590	9550	12030	15280	19100	23870
125	1830	2440	3060	3820	4890	5350	6110	6875	7640	9630	12220	15280	19100
150	1530	1040	2550	3180	4070	4460	5090	5730	6370	8020	10190	12730	15920
175	1310	1850	2180	2730	3490	3820	4370	4910	5460	6880	8730	10910	13640
180	1270	1700	2120	2650	3400	3710	4240	4775	5310	6680	8490	10610	13260
200	1150	1530	1910	2390	3060	3340	3820	4230	4780	6020	7640	9550	11940
230	1000	1330	1660	1080	2660	2910	3320	3740	4150	5230	6640	8300	10380
250	920	1230	1530	1910	2440	2670	3060	3440	3820	4810	6110	7640	9550
300	765	1020	1270	1590	2040	2230	2550	2865	3180	4010	5090	6370	7960
350	655	875	1090	1365	1745	1910	2180	2455	2730	3440	4370	5460	6820
400	575	765	955	1195	1530	1670	1910	2150	2390	3010	3820	4780	5970
450	510	680	850	1060	1360	1485	1700	1910	2120	2670	3400	4240	5300
500	460	610	765	955	1220	1335	1530	1720	1910	2410	3060	3820	4780
600	380	510	640	795	1020	1115	1590	1430	1590	2000	2550	3180	2980
650		470	588	735	940	1030	1180	1320	1470	1850	2350	2940	
700		437	546	682	873	955	1090	1230	1360	1720	2180	2730	
750		407	509	637	815	891	1020	1150	1270	1300	2040	2550	
800		328	477	597	764	836	955	1070	1190	1500	1910	2390	
900		340	424	531	679	743	849	955	1060	1340	1700	2120	
1060		288	360	450	577	631	721	811	901	1140	1440	1800	
1250		245	305	380	488	534	610	685	760	960	1020	1525	

v – peripheral speed (m/s)
d – grinding wheel diameter (mm)
n – revolutions per minute (rpm)

The peripheral speed of a grinding wheel is determined according to the following equation:

$$v = \frac{d \cdot \pi \cdot n}{60000}$$

The necessary number of wheel revolutions per minute is determined according to the following equation:

$$n = \frac{60000 \cdot v}{d \cdot \pi}$$



INSPECTION AND MOUNTING OF GRINDING TOOLS

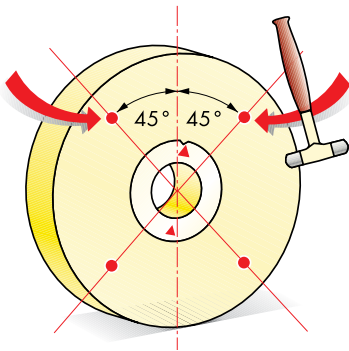

During work, users must follow the instructions of the tool and machine manufacturer(s), and most importantly:

- Provide adequate storage for the grinding tools
- Inspect grinding tools before mounting
- If necessary, balance and correctly mount grinding tools
- Correctly prepare the grinding machine
- Test the grinding tool while unloaded

Grinding tools are usually stored in cardboard packaging or wooden cases and shipped on wooden pallets. Packaging does provide for safe transport; nevertheless the cartons or cases must not be thrown during reloading.

After their receipt at the warehouse and especially directly before mounting onto the grinding machine, the grinding tool must be inspected; circular grinding tools must also be ring tested to detect any damage that may have occurred during transport or storage. Ring testing of grinding tools is performed by lightly hitting a suspended tool in four places with a metallic or wooden hammer; the tool must yield a clear ringing sound. If the sound is dull, the tool is probably damaged.

Grinding tools must always be mounted by properly trained and experienced personnel. In addition to visual inspection and ring testing, dimensions, quality and max. peripheral speed also need to be checked prior to mounting. Grinding tools should be mounted easily on the spindle or a clamping device (without the use of force or hammering) and must ensure safe clamping. The enclosed cardboard flange should be placed between a grinding wheel and the clamping part (steel flange or clamping jaw). The maximum permissible imbalance of grinding wheels is calculated using the following equation:

The permitted grinding wheel imbalance is calculated according to the following equation:

m_n = permitted imbalance

K = factor

M = grinding wheel mass in g

$$m_n = K \cdot \sqrt{M}$$

Required diameters for stated peripheral speeds	K
Up to 40 m/s	
- grinding wheels up to 305 mm	0.25
- grinding wheels between 305 and 610 mm	0.32
- grinding wheels over 610 mm	0.40
Up to 63 m/s	
- grinding wheels up to 305 mm	0.20
- grinding wheels between 305 and 610 mm	0.25
- grinding wheels over 610 mm	0.32
Up to 100 m/s	
- grinding wheels up to 305 mm	0.16
- grinding wheels between 305 and 610 mm	0.20
- grinding wheels over 610 mm	0.25

Grinding tools of greater dimensions, which are mounted on a flange and onto a machine spindle together with the flange, need to be statically balanced with flange weights.

If the grinding wheel is not statically balanced, vibrations appear during grinding; this causes greater tool wear, lower ground surface quality, and shorter life of the main machine spindle bearings; the wheel may also split during work due to centrifugal force.

The procedure for static balancing of the grinding wheel involves manual positioning of weights into flange grooves, so that the total mass of the wheel and weights is evenly distributed along the circumference.

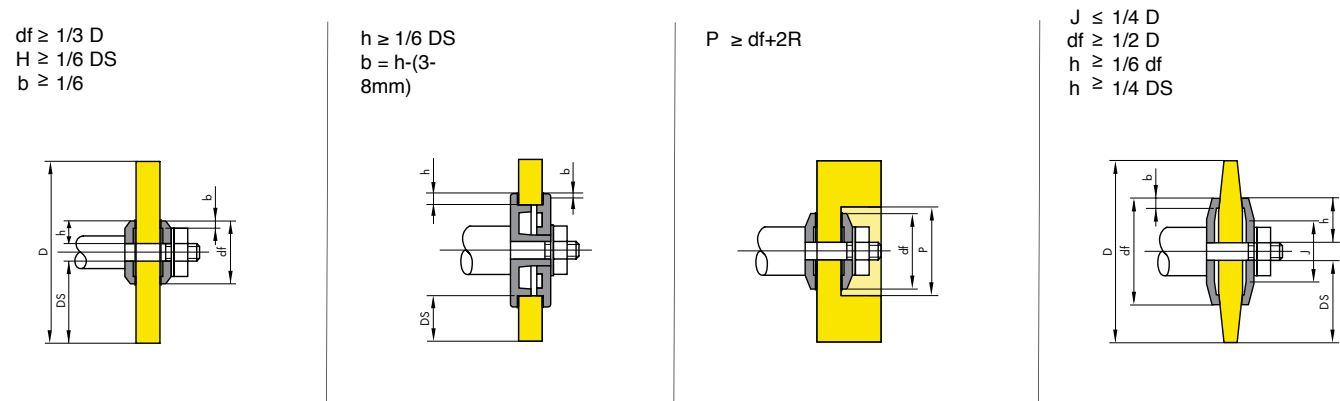

Recommended grinding parameters for vitrified bonded grinding wheels with CBN and diamond grit :

	Grinding wheel peripheral speed (m/s)	Workpiece peripheral speed	Longitudinal motion (m/min)	Transverse motion (mm/stroke)	Grinding depth (mm)
External cylindrical grinding	30 - 35	10 - 25	0,5 - 1,0		0,01 - 0,05
Internal cylindrical grinding	8 - 35	10 - 30	0,3 - 1,0		0,002 - 0,005
Peripheral surface grinding	30 - 35		8 - 10	0,3 - 0,6	0,04 - 0,1
Thread grinding	30 - 45	0,2 - 0,5			To 0,4/stroke
Tool sharpening (for machining of metals)	35 - 40		1,0 - 2,0		0,03 - 0,08
Flute grinding	25 - 30		2,0 - 2,5		0,01 - 0,06





START OF GRINDING

After mounting, and before grinding can begin, the following operations need to be performed:

- Set the machine so that it rotates at the maximum operating speed and appropriately protects the danger zone.
- Switch the machine on and leave the wheel to rotate for 1 minute prior to grinding.
- Prepare the coolant.
- Dress the grinding tool (diamond dressing tool).

Incorrect handling may cause damage to the grinding wheel or machine, or a work accident.

Recommended grinding parameters for individual types of grinding:

	Application	Grinding wheel periph.speed (m/s)	Workpiece periph.speed (m/min)	Longitudinal motion (m/min)	Transverse feed (mm/min)	Grinding feed (mm)
Surface grinding						
	- general applications	25 - 30				
	- for high-alloyed steel	23 - 28				
	- for cast iron	20 - 25	/	5 - 20	(0.25 - 0.33)	0,01 - 0.03
	- for tungsten carbides	15 - 20			*T	
	- for non-ferrous metals	15 - 20				
External cylindrical grinding						
	- for coarse types of grinding intended for cleaning purposes	25 - 32		2 - 5 mm / workpiece revolution	/	0.005 - 0.03
	- for dressing	25 - 32	5 - 20			
	- for fine grinding	20 - 30 (63)				
	- for the finest grinding	12 - 18				
Centerless external cylindrical grinding						
	- general applications			Guide plate angle $\alpha = d_o 5^\circ$	/	0.005 - 0.03
		30 - 40 (63)	10 - 50			
Circular grinding - internal cylindrical grinding						
	- general applications	25 - 32				
	- for high-alloyed steel	15 - 20				
	- for cast iron	15 - 20	5 - 15		/	0.005 - 0.03
	- for tungsten carbides	8 - 15				
	- for non-ferrous metals	15 - 20				
	- bearings	63 - 80				
Tool sharpening						
	- for tool steels	25 - 30				
	- for high-speed steels	25 - 30	/	/	/	0.005 - 0.015
	- for tungsten carbides	8 - 15				

Constant cooling of the diamond tip is necessary during surface dressing and profiling in order to prevent changes of the diamond properties.

Once the sharp edges of the grinding wheel cutting surface are worn out (as indicated by an increase in the normal force F_n , and an inefficient and loud grinding wheel), they need to be restored, i.e. surface dressed. Various surface dressing tools are used for dressing of grinding wheels:

Manual surface dressing:

Depending on the required accuracy, surface dressing may be performed with:

- vitrified bonded dressing tools,
- little metal wheels,
- single grit diamond dressing tools,
- multigrain diamond dressing tools.



Machine surface dressing:

Single point dressing tools (with bases of different shapes),



Dressing plates (attached to holders of different shapes),



Multipoint dressing tools (with bases of different shapes),



Diamond rolls (attached to holders of different shapes)



When a grinding wheel is mounted onto the machine spindle, it needs to be dressed for as long as it takes to level the entire grinding surface. If surface dressing is done during grinding, correct selection of the dressing parameters is important.

Dressing depth depends on the grit size in the grinding wheel, and is the same for all types of dressing tools.

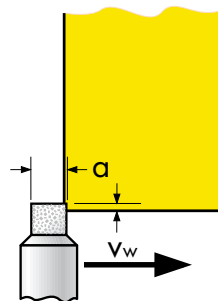

Grit size according to FEPA	Dressing depth a (mm)
46	0,35
60	0,30
80	0,25
120	0,10
150	0,08
220	0,06
320	0,03
400	0,02

The other parameters are determined with respect to the dressing tool type.

SURFACE DRESSING WITH SINGLE POINT DIAMOND DRESSING TOOLS

Selection of diamond grit size:

The grit size of a single grit surface dressing tool depends on the grinding wheel size, and is determined using an equation or a diagram.

$$C_t = \frac{D + 2\check{S}}{400}$$

C_t - diamond grit size
 D - grinding wheel diameter
 \check{S} - grinding wheel width
 400 - constant

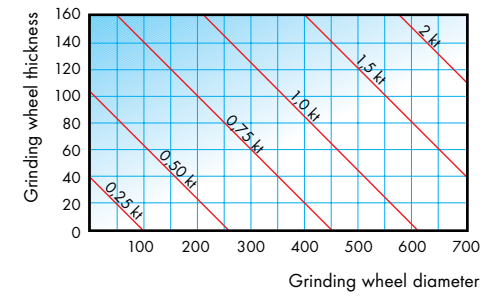

Depending on the shape, diamond grits for dressing tools are classified into four basic types.

No. of tips	Quality class
1 to 2	STANDARD
2 to 3	EXTRA

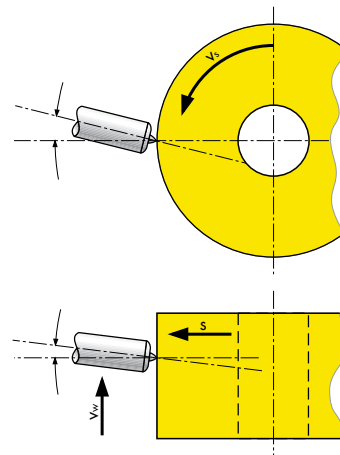

$$b = \max(2 \cdot a)$$

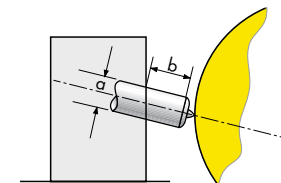



Dressing tool's transverse stroke:

Transverse stroke during dressing (mm/min) with single grit surface dressing tools depends on the type of grinding and the external grinding wheel diameter. The recommendations are as follows:

At operating speed of 35 m/s

Type of grinding	Grinding wheel diameter (mm)				
	Ø200	Ø300	Ø400	Ø500	Ø600
Coarse grinding	780	520	400	300	260
Normal grinding	380	260	200	150	130
Fine grinding	280	150	120	100	80

At operating speed of 50 m/s

Type of grinding	Grinding wheel diameter (mm)				
	Ø200	Ø300	Ø400	Ø500	Ø600
Coarse grinding	1000	730	560	420	360
Normal grinding	530	360	280	210	180
Fine grinding	390	210	170	140	110

Restoration of single grit diamond dressing tools

Once the surface dressing tip has become worn out (i.e. when the contact surface area exceeds 1mm²), the dressing tool needs to be restored. Restoration turns the grit around or grinds it and turns it around.



New dressing tool



Worn out dressing tool

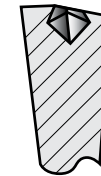

Useless dressing tool

SURFACE DRESSING WITH MULTIPOINT DIAMOND DRESSING TOOLS

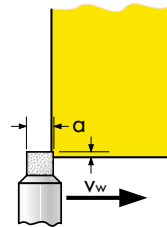

Multipoint dressing tools:

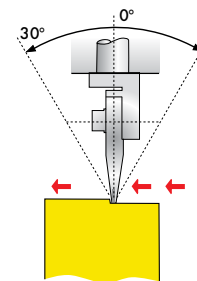

Dialettes:

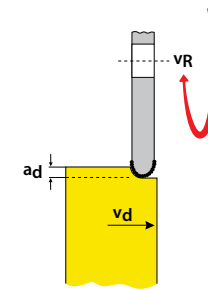

Diamond rolls:

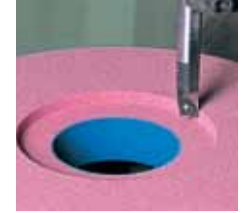

PROFILING OF GRINDING TOOLS

Single point diamond dressing (profiling) tools:

These are used for profiling vitrified bonded grinding wheels and are named according to the profiling device or machine.

Flat diamond dressing tools-Dialettes:

These are classified according to the shape and quality of the integrated diamond grit.

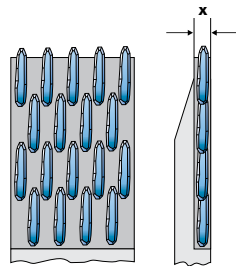

Dialette with pins

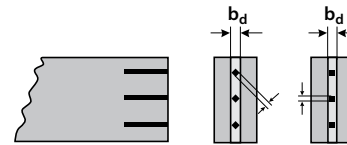

Dialette with MCD
(monocrystalline diamond) pins:

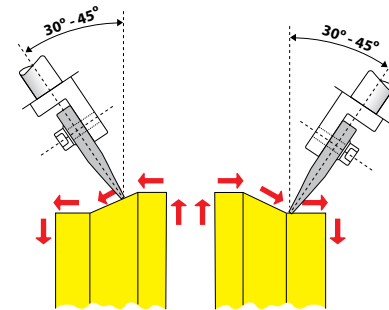

Dialette position in relation to the grinding wheel during dressing.

Rotating diamond dressing tools:

Rotating diamond dressing tools:

Depending on the dressing method, rotating diamond dressing tools are produced:

- with the entire profile shape (without transverse motion):
- with the same profile as the model (with transverse motion):

Depending on the bond type, rotating dressing tools may be produced with:

- galvanic bond,
- metal bond.

When profiling is done using a template (programme), the dressing wheel's profile must be the same as that of the model. The dressing tool moves along a template, creating the same profile along the grinding wheel circumference.

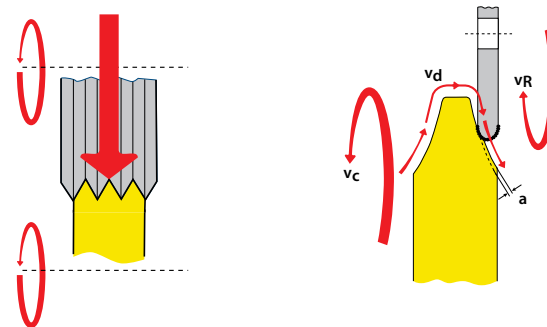

DRESSING OF DIAMOND AND CBN GRINDING TOOLS

Superabrasives grinding wheels may be dressed with:

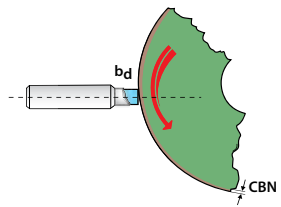

Multipoint sintered dressing tools

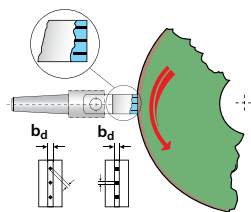

Dialettes with MC grit

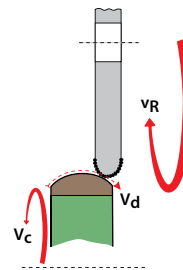

Diamond rolls

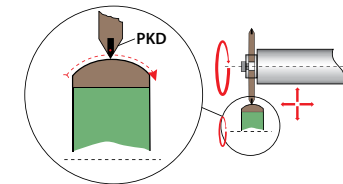

PKD profiling grinding wheels

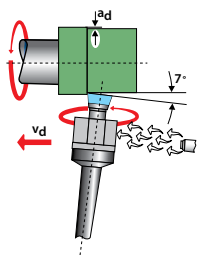

Dressing tools with rotating wings

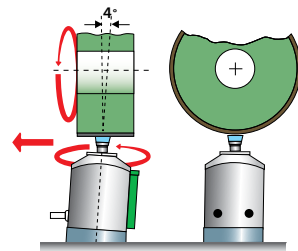

Universal WST diamond dressing tools

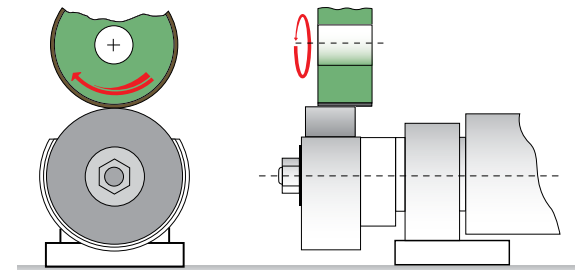

Dressing tools with centrifugal brake

K101 MK1

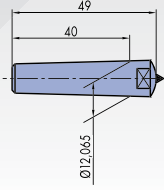

K102 MK1-G

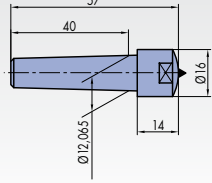

K111 YUNG

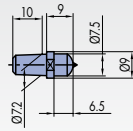

K115 NILES

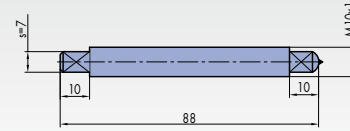

K301 (15x6)

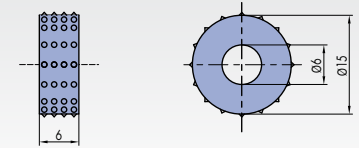

K103 MK0

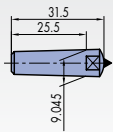

K104 MK0-G

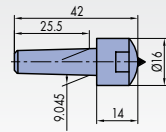

K113 KOLB

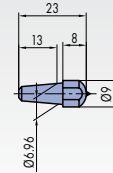

K117 DECKEL

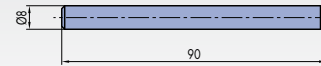

K303 (20x8)

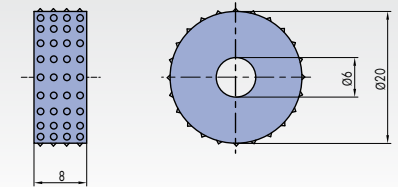

K105 DECKEL

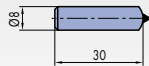

K106 ZYLINDER

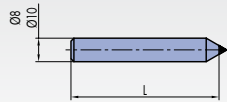

K112 YUNG

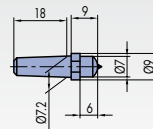

K116 NILES

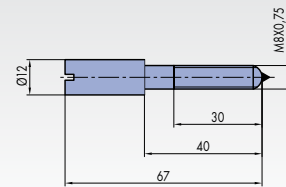

K302 (20x8)

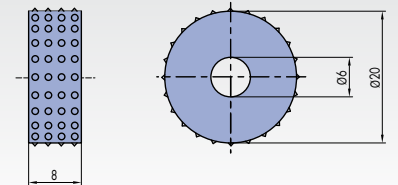

K107 YUNG

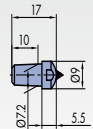

K108 YUNG

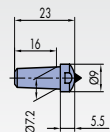

K114 LANDIS

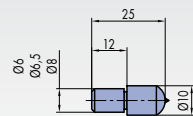

K119

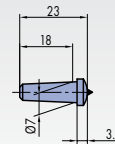

K109 YUNG

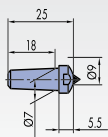

K110 YUNG

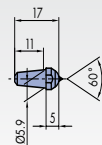

Diamond roll clamping

HOLDER MK1, MK0, ...

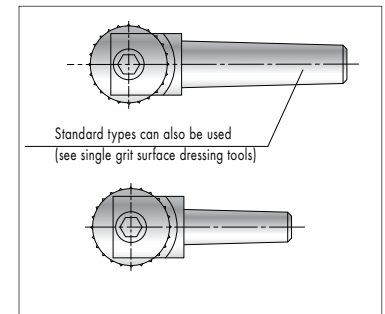

Order printout sample:
K101 MK1-2,5 kt - standard

DIAMOND DIALETTES

DIALETA 10xL

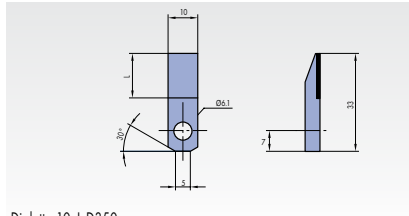

Dialette 10xL D350

DIALETA 20xL

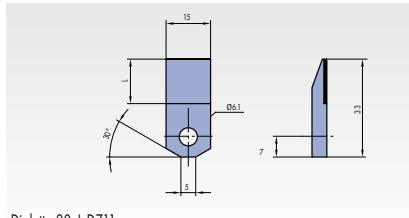

Dialette 20xL D711

DIALETA 15xL

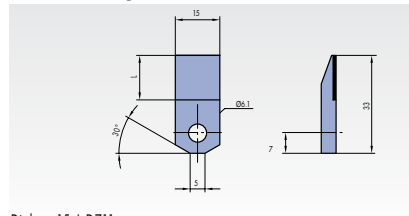

Dialette 15xL D711

Fixed clamping into a holder

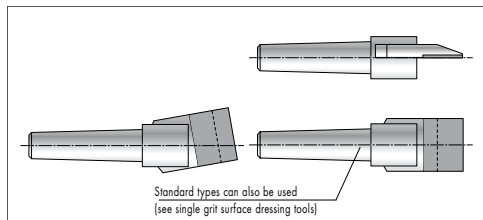

Clamping into screw holders

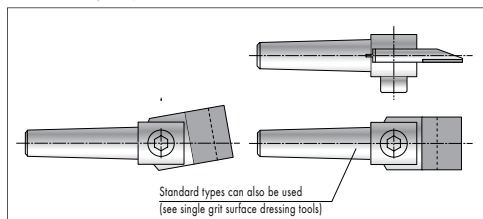

DIAMOND INSERTS FOR MULTIPOINT DRESSING TOOLS

K401 6x8

(Diamond grit size D 711)

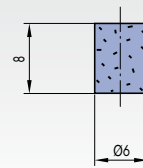

K402 6x8

(Diamond grit size D 350)

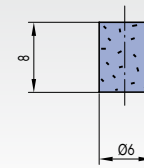

K403 8x8

(Diamond grit size D 711)

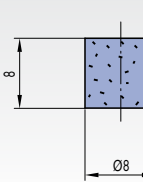

K404 8x8

(Diamond grit size D 350)

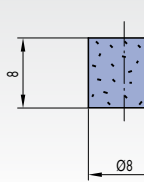

K405 10x10

(Diamond grit size D 711)

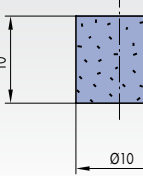

K406 10x10

(Diamond grit size D 350)

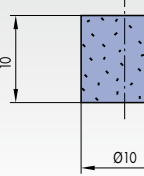

Types of multipoint dressing tools

HOLDER: MK0, MK1, ...

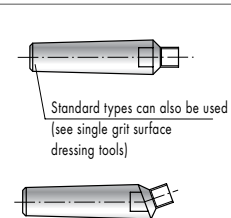

K404 MK0 8x8 1 kt

MK0-G, MK1-G, ...

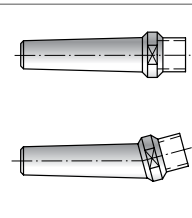

K406 MK1-G/10x10 1,5 kt.

CYLINDRIC HOLDER

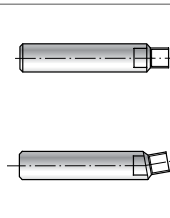

K401 8x8/6x8 0,75 kt.

PROFILE DIAMOND DRESSING TOOLS



K201 DIAFORM

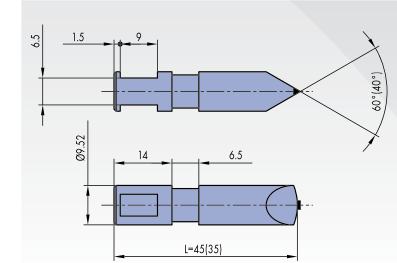

K202 FORTUNA

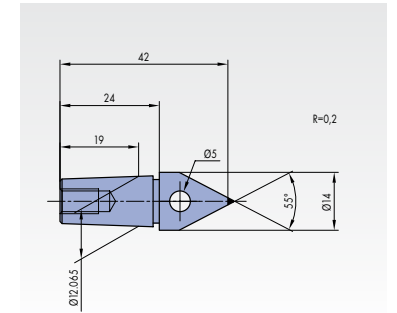

K203 SCHAUDT

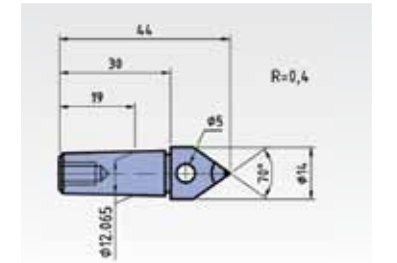

K204 JUNG

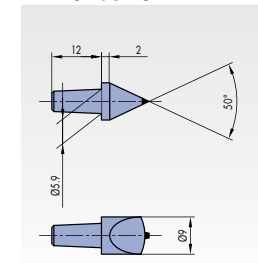

COOLANTS



The purpose of a coolant is to cool the workpiece and grinding wheel during machining and to lubricate the ground surface. Cooling of the workpiece and tool is necessary to eliminate the unwanted effects of heat on both the workpiece and tool.

Lubrication is needed to reduce friction between the tool and workpiece and protect the workpiece from corrosion.

Types of coolants

The following materials are used as coolants:

- oil for machining where very smooth surface is required,
- mineral, white emulsion - emulsion of oil in water with added emulsifiers and antibacterial additives; universally applicable,
- synthetic, clear emulsion - emulsion of synthetic oils in water; resistant to bacteria,
- synthetic coolants.

The coolant type and concentration depend on the machining method and type of material worked. It is recommended that the user consult the producer of coolant regarding the type of coolant and its concentration.

Most important properties of coolants:

- good cooling and lubrication,
- prevention of corrosion,
- physical, chemical and technological stability during use,
- no harmful effects on human health,
- no excessive foaming.

Cooling during machining

A sufficient amount of a coolant needs to be supplied at a certain pressure to the worked area during machining in order to perform this function. If the coolant is not supplied to the right place, its effects are suboptimal.

The figures show the points/places to which the coolant needs to be supplied for individual types of grinding.

Reducing the amount of a coolant because it is sprayed around the work area may cause defects on the workpiece (cracks, thermal changes and similar problems).

During work and after it, the grinding wheel should not remain immersed in the coolant, because it might break during next use due to imbalance. When work is completed, the grinding wheel should be centrifuged to prevent damage upon reuse. Newer machines are constructed in such a way that the machining zone and thus also the cooling zone are enclosed and the coolant cannot be sprayed around.

Surface grinding

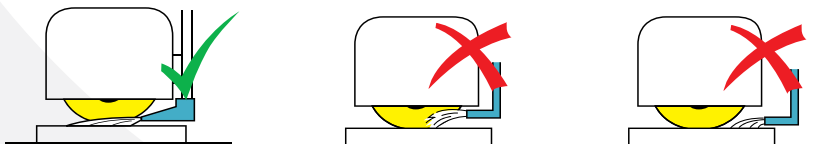

External grinding

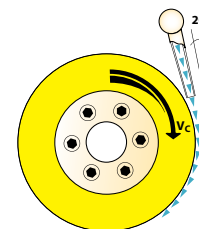

Internal grinding

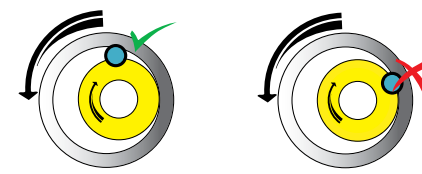



Cooling during surface dressing

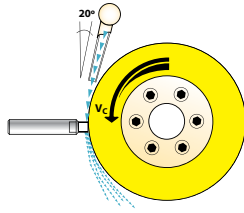

Coolant maintenance

Selection of the shape and dimensions of grinding wheels is limited by the machine (the machine manufacturer prescribes/recommends the shapes and maximum dimensions of grinding wheels which can be used on the machine). When one has a choice, the highest permissible peripheral speed of the grinding wheel should be used as a guidance as prescribed by the manufacturer, along with the machine rpm setting options and the grinding method. The grinding wheel quality required for individual grinding methods should be selected as shown below.

During surface dressing, cooling is necessary to lead heat away from the machining zone or to maintain the diamond's temperature stability. If the temperature in the dressing zone exceeds 620°C , a layer of graphite begins to be formed on the diamond surface, but if the temperature increases to 1200°C , all of the diamond grit will be transformed to graphite. If a coolant is not supplied during surface dressing or profiling in order to cool the surfaces and wash away the chips, some chips may be pressed into the grinding wheel surface, changing the grinding wheel shape.

Coolants need to be cleaned before they are supplied to the cutting site, so that the chips would not cause damage to the ground surface. A coolant cleaning device is usually positioned between the work area and the coolant tank, so that the coolant can be purified prior to its repeat use. The most common used cleaning devices are:

- magnetic coolant cleaner,
- paper cleaner,
- centrifugal cleaner,
- magnetic-paper cleaner.

The concentration and the pH value of the coolant should also be monitored regularly, because they might change due to high temperatures (water evaporation).

SELECTION OF GRINDING WHEEL TYPE, DIMENSIONS AND SPECIFICATION

There are a few general principles which apply to the selection of grinding wheel quality:

Selection of abrasive grain type:

In selecting abrasive grit, the workpiece material and its condition should be taken into account.

The general rule is that corundums should be used for grinding of steel materials, while for non-steel materials silicon carbides are considered to be the most appropriate.

Selection of abrasive grain size:

In selecting abrasive grit size, the surface quality expected after grinding should be known.

The abrasive grit size should be selected from the table or diagram based on the required roughness of the ground surface.

Selection of grinding wheel hardness and structure:

In order to be able to select the correct grinding wheel hardness and structure, the condition of the ground material needs to be known (primarily its quality, hardness and any surface treatment/machining). When hardness is selected, it is important to select a softer grinding wheel for grinding harder materials and vice versa, i.e. a harder grinding wheel for grinding softer materials. There are certain principles which apply to grinding wheel hardness and structure, namely that it is impossible to manufacture low-hardness grinding wheels with a very closed structure and vice versa. When determining the grinding wheel hardness and structure, the use of a coolant is also relevant, i.e. with cooling, harder grinding wheels can be used than without it.

Bond selection:

Grinding wheels of various bonds are available for grinding. Recommendations for selecting vitrified bonded grinding wheels are given below.

The most common mistakes related to incorrect grinding wheel specification or inadequate machine settings:

If grinding does not yield satisfactory results, this means that you have selected an inappropriate grinding wheel quality or that there are some errors on the machine.

Appropriate grinding tool specification for each grinding application and for machining of standard materials are recommended below. The recommended specification are stated for general applications only. In the case of special grinding cases and for grinding of special materials, the user is advised to consult with the professional staff of the grinding tool manufacturer.

PROBLEMS	REASONS	SOLUTIONS
The ground surface becomes excessively overheated.	The selected grinding wheel is too hard. The grinding wheel is poorly balanced; the spindle bearings have play in them.	Reduce grinding wheel hardness. Produce a more open grinding wheel; reduce the working pressure and the grinding wheel's peripheral speed.
There may be vibrations on the machine.	The selected grinding wheel is too hard. The grinding wheel is poorly balanced; the spindle bearings have play in them.	Select a softer and more open grinding wheel. Check the grinding wheel's balance; fix machine settings.
The grinding wheel wears out very quickly.	The selected grinding wheel is too soft; grinding is done with excessive work pressure.	Select a harder and less porous grinding wheel. Reduce the working pressure and increase the grinding wheel's peripheral speed.
The grinding wheel's cutting edge does not maintain its shape.	The selected grinding wheel is too soft; the grit is too coarse.	Select a harder and less porous grinding wheel; select finer grit.
The material removal rate is too low.	To fine gritsize.	Select a coarser and softer grinding wheel; reduce grinding depth.
The grinding wheel's working surface becomes clogged too soon.	The selected grinding wheel is too fine; it is also too hard and too closed.	Select a coarser grinding wheel; select a softer and more open grinding wheel.
The ground surface is too rough.	The selected grinding wheel is too coarse.	Select a finer grinding wheel. Work with smaller moves and cutting depths; achieve a smoother surface by applying several grinding strokes.

ORDERING

When ordering grinding tools, please state all the necessary parameters in your order: tool type, dimensions and specification. For repeat orders, grinding tool identification number will suffice. The grinding wheel specification is determined as follows:

- If you are already using the grinding tool, order an identical one (all data required for the order can be found on the cardboard flange or adhesive label on the product). If your grinding tool is not manufactured by SWATYCOMET, please add the manufacturer's name in your order (in addition to the prescribed data).
- If you have no information on the grinding tool specification or are just beginning to grind, state all data on the machine, grinding method, ground material and required ground surface roughness in your order, or consult our technicians (fill out the TECHNICAL ORDER FORM).

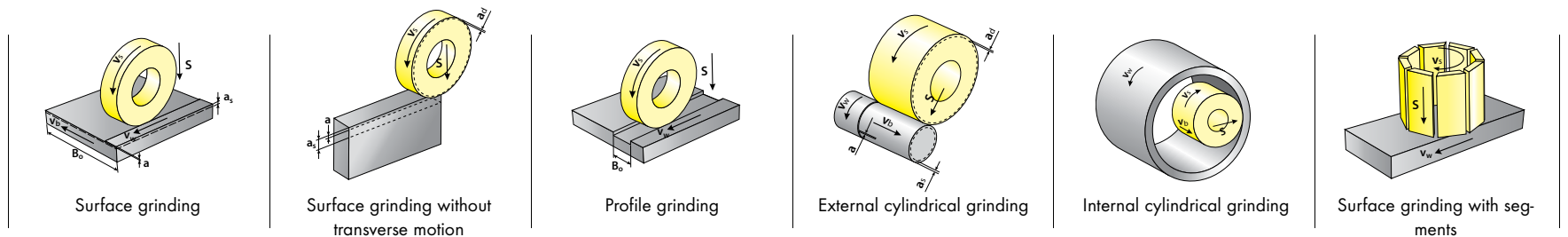

v_s - peripheral speed
 v_w - speed of workpiece motion
 v_b - transverse workpiece speed

s - tool transverse feed rate
 a - grinding depth per turn
 a_s - total grinding depth
 B_o - ground surface width

G - volume grinding factor
 V_w - volume of removed material
 V_s - amount of wear on wheel

$$G = V_w / V_s$$



TECHNICAL ORDER FORM

Work order No.: _____
 Type and specification: _____
 Dimension of grinding wheel: _____

Customer: _____
 Address: _____
 Contact person: _____
 Phone: _____

TESTED SAMPLE:

Tested sample:
 Appropriate Semi appropriate
 Inappropriate, why? _____

DATA ON THE WORKPIECE:

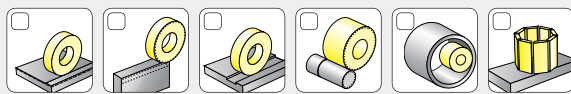
Description: _____ Material: _____
 Hardness: _____ Surface finish: N,Ra,Rt,Rz _____
 GRINDING  Other method: _____
 METHOD: _____
 Grinding machine: _____ Power of main spindle P_s : _____ W
 Grinding wheel peripheral speed v_s : _____ m/s or RPM _____ min^{-1}
 Workpiece speed v_w : _____ m/min or RPM _____ min^{-1}
 Infeed a : _____ mm
 Transverse speed v_b : _____ mm
 Grinding allowance a_s : _____ mm
 Other process parameters: _____
 Cooling: YES NO Coolant type (designation): _____ Flow rate (pressure): _____ l/min

TEST GRINDING REPORT:

Surface finish: _____ Observations : _____
 Material removal volume V_w : _____
 Grinding wheel layer volume V_s : _____
 Process (grinding) time t_s : _____
 Dressing infeed a_d : _____
 Frequency of dressing: _____
 G ratio $G = V_w / V_s$: _____

COMPARISON WITH SIMILAR GRINDING WHEELS FROM OTHER MANUFACTURERS:

Manufacturer: _____
 Wheel designation: _____
 Notes: _____
 Better Equal Worse

Signature, date:



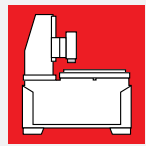

Grinding wheel 1

D x T x H

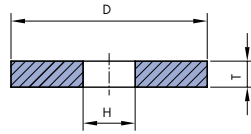

D	T	H
100	10 - 102	10, 13, 16, 20, 25, 32
125	10 - 102	13, 16, 20, 25, 32, 40
150	10 - 152	13, 16, 20, 25, 32, 40
200	10 - 152	13, 16, 20, 25, 32, 40, 51
225	10 - 152	16, 20, 25, 32, 40, 50, 60
250	10 - 152	20, 25, 32, 40, 51, 76
300	10 - 152	32, 40, 51, 76, 127
350	10 - 152	32, 40, 51, 76, 127, 152.4
400	10 - 203	40, 51, 76, 127, 152.4, 203
450	10 - 254	76, 127, 152.4, 203, 254, 305
500	20 - 254	127, 152.4, 203, 254, 305
600	20 - 254	127, 152.4, 203, 305

CBN-V Grinding wheel 1A1

D x T x X x H

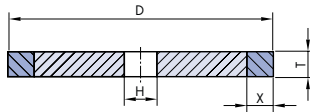

D	U	X	H
100	5 - 25	6/6.4/8/10/12/12.5/15	20/25/32
125	5 - 25	6/6.4/8/10/12/12.5/15	20/25/32
150	5 - 25	6/6.4/8/10/12/12.5/15	20/25/32
175	2 - 25	6/6.4/8/10/15/20/25	20/25/32/40
200	5 - 30	6/8/10/12/12.5/15/20/25	20/25/32/40/51
220	5 - 25	6/10	20/25/32/40/51
250	10 - 30	6/8/10/12/15	25/32/40/51/76
300	10 - 25	8/10/12	32/40/51/76/127

CBN-V Grinding wheel 1A1-K

D x T x X x H

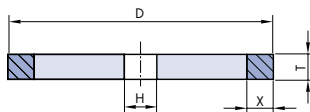

Order printout sample:
1A1 - K 400 x 20 x 5 x 127
B126 O6V3 C100

D	U	X	H
250	10 - 30	5/6/8/10/12/15	25/32/40/51/76
300	10 - 25	5/6/6.4/8/10/12	32/40/51/76/127
350	10 - 25	5/8/10/15/25	32/40/51/76/127/151
400	10 - 25	5/6.4/10/12.5/20	51/76/127/151/203
450	10 - 25	5/10/12.5/20	76/127/151/203
500	10 - 25	6.4/10	76/127/151/203



Grinding wheel 5

D x T x H - P x F

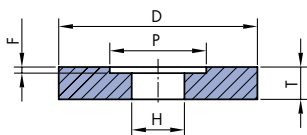

D	T	H	P	F
100	10 to 102	16, 20, 25, 32, 40	60	
125	10 to 102	25, 32, 40, 51	75	
150	10 to 152	25, 32, 40, 51	75	
200	10 to 152	25, 32, 40, 51	110	
225	10 to 152	25, 32, 40, 51	110	
250	10 to 152	32, 40, 51, 76, 100	130	
300	10 to 152	32, 40, 51, 76, 127	190	
350	10 to 152	76, 127, 152,4	215	
400	10 to 203	127, 152.4, 203	230	
450	10 to 254	127, 203, 254, 305	290	
500	20 to 254	152.4, 203, 305	290	
600	20 to 254	152.4, 203, 305	290	

F = max. T/2

Grinding wheel 7

D x T x H - P x F/G

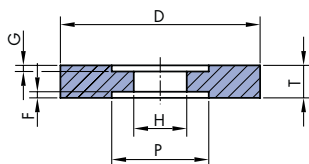





D	T	H	P	F,G
100	10 to 102	16, 20, 25, 32, 40	60	
125	10 to 102	25, 32, 40, 51	75	
150	10 to 152	25, 32, 40, 51	75	
200	10 to 152	25, 32, 40, 51	110	
225	10 to 152	25, 32, 40, 51	110	
250	10 to 152	32, 40, 51, 76, 100	130	
300	10 to 152	32, 40, 51, 76, 127	190	
350	10 to 152	76, 127, 152.4	215	
400	10 to 203	127, 152.4, 203	230	
450	10 to 203	127, 203, 254, 305	290	
500	20 to 254	152.4, 203, 305	290	
600	20 to 254	152.4, 203, 305	290	

F+G = max. T/2

Order printout sample:
7 300x50x127-100x15/10
82A 46 G12 V

Products of other dimensions can be made to special order.



	Quality class/Specification	
	STANDARD	EXTRA
Application:		
Universal - multipurpose:		
 Non-hardened steel:	2A46JV	3GA46J6V
Hardened steel:	82A46H12V	3GA46H12V
Special grinding		
Non-hardened steel (steel for automatic machines and structural steel):	2A46H8V	
Hardened steel (low-alloy, up to 60 HRc)		
- Quenched and tempered steels	2A46H12V, 82A46H12V	3GA60G12V
 Hardened steel (high-alloy, over 62 HRc)		
- Tool steels	82A46H12V	3GA60F12V, B126M6VR
- High-speed steels (HSS)	8A60F12V, 18GA60F12V	3GA46F12V
Stainless steel (INOX):		
- Non-hardened steel	4A60H12V, C60H12V	
- Hardened steel	84A60G12V	
Nitriding steels:		
- Not thermally treated steels - core	82A46H8V	
- Nitriding	C60H12V, C60F12V (>62HRc)	
 Casting:		
- Steel cast iron	82A60H12V	
- Gray cast iron	C60H12V	
- Timed and nodular iron	82A60H12V	
 Tungsten carbides (HM) and ceramic:	C60H12V	
Non-metals and non-ferrous metals:		
 - aluminium, copper, bronze,..	2A46J8V, C46H12V	
- Rubber	2A36G12V, 1A24J7V	



Grinding segment 31A

B x C x L

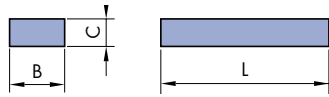

B	C	L
80	25	150
90	35	200
110	40	180
120	30	200
120	40	180
120	45	200

Grinding segment 31B

B/A x C x L

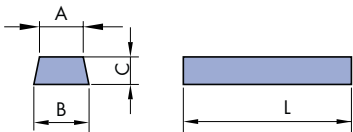

B	A	C	L
50	40	25	110
60	54	22	120
70	64	25	110
100	85	35	150
106	93	38	200
120	106	41	200

Grinding segment 31C

B/A x C x L - R

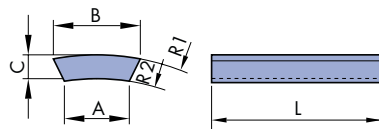

B	A	C	L	R
50	40	20	115	150
79	70	20	140	150
90	55	35	125	175
95	70	25	102	150
106	80	25	150	180
120	65	50	90	180
155	95	59	160	225

Order printout sample:
31C 95/70X25X102 - R150
2A46H12V

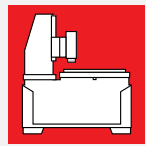

Grinding segment 31D

B/A x C x L - R

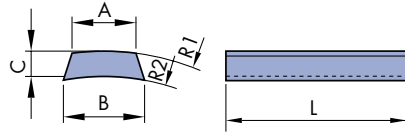

B	A	C	L	R
50	45	16	90	90
50	46	15	100	90
68	57	30	130	130
81	72	20	80	186

Grinding segment 31BA

B/A x C x L - R

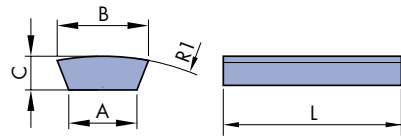

B	A	C	L	R
117,5	79,6	44,5	203	254
165	113	56	305	762

Grinding segment 31BB

B/A x C x L - R

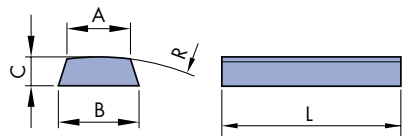

B	A	C	L	R
70	64	25	150	150
103	83	38	150	250
103	83	38	180	250
103	85	38	203	230

Order printout sample:
 31BB 165/113x56x305 - R76A
 2A46H12V



Grinding ring 2

D x T - W

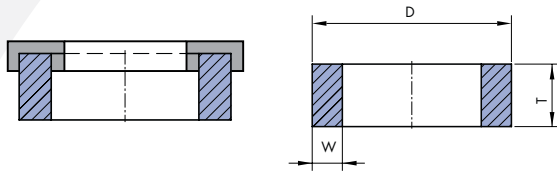

D	T	H
100	90	10
125	80	32
150	90	15
175	90	20
200	90	20
250	100	25
300	120	32
350	125	40
400	125	40

Cylindrical grinding cup 6



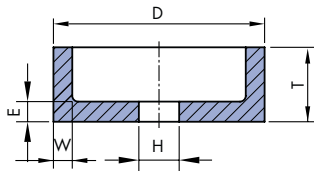

D x T x H - W, E



D	T	H	W	E
50	32	13	5	8
80	40	20	6	10
100	50	20	8	10
125	63	20	8	13
150	80	20	10	16
175	100	32	15	20
200	100	32	20	25
250	100	76	20	25

Order printout sample:
 6 150x80x20 -W10 E16
 4A60 H12V



	Specification	
	Type 2, 6	Type 31..
 Application:		
Universal - multipurpose:		
Non-hardened steel	2A46H8V	2A24J7V
Hardened steel:	82A46H12V	2A46H12V
Special grinding:		
Non-hardened steel (structural steel):	2A46H8V	2A24H7V, 3GA46F12V
Hardened steel (alloy up to 60 HRC) - Tempered steels	2A46H12V, 82A46H12V	2A36H8V
 Hardened steels (high alloy over 62 HRC)		
- Tool steel	82A46H12V	4A36E12V, 3GA36F12V
- High-speed steels (HSS)	8A60F12V, 18GA60F12V	
Stainless steel (INOX):		
- Non-hardened	4A60H12V, C60H12V	2A24H7V
- Hardened	84A60G12V	2A36G8V
Nitriding steels:		
- Not thermally treated - core	4A46H8V	2A24H7V
 Casting:		
- Steel cast iron	82A46H12V	2A24H7V
- Gray cast iron	82A46H12V	C36H9V, 42A36H11V
- Timed and nodular iron	C46H12V	C46H12V
Carbide alloy (HM)	C46H12V	C60H6V
Ceramic:	C46H8V	C36H7V
 Non-metals and non-ferrous metals:		
- aluminium, copper	C46H8V	C36H12V
 Band saws (form 6)	2A80M8VR1	



Grinding wheel 1 and CBN-V 1A1

D x T x H

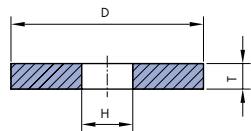

D	T	H
100	10 to 32	10, 13, 16, 20, 25, 32
125	10 to 32	13, 16, 20, 25, 32, 40
150	10 to 32	13, 16, 20, 25, 32, 40
200	10 to 32	13, 16, 20, 25, 32, 40, 50.8
225	10 to 32	16, 20, 25, 32, 40, 50.8, 60
250	10 to 32	20, 25, 32, 40, 50.8, 76.2
300	10 to 50	32, 40, 50.8, 76.2, 127
350	16 to 50	32, 40, 50.8, 76.2, 127, 152.4
400	20 to 80	40, 50.8, 76.2, 127, 152.4, 203.2
450	20 to 80	76.2, 127, 152.4, 203.2
500	25 to 100	76, 127, 152.4, 203.2
600	32 to 100	152.4, 203.2, 304.8
750	32 to 125	304.8
800	32 to 125	304.8
900	32 to 125	304.8
1060	32 to 160	304.8
1250	32 to 160	304.8

Grinding wheel 5

D x T x H - P x F

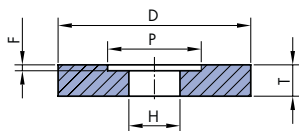

D	T	H	P	F
100	10 to 32	25, 32, 40		60
125	10 to 32	25, 32, 40, 50.8		75
150	10 to 32	25, 32, 40, 50.8		75
200	20 to 40	25, 32, 40, 50.8		110
225	20 to 40	25, 32, 40, 50.8		110
250	20 to 40	40, 50.8, 76.2		130
300	32 to 80	76.2, 127		190
350	40 to 80	76.2, 127		215
400	40 to 80	127		215
450	40 to 100	127		215
		203.2		290
500	40 to 160	203.2		290
		304.8		390
600	40 to 160	203.2		290
		304.8		390
750	63, 80, 100, 125	304.8		410
900	63, 80, 100, 125	304.8		410
1000	63, 80, 100, 125	304.8		410
1060	63, 80, 100, 125	304.8		410
1250	63, 80, 100, 125	304.8		410

F = max. T/2

Order printout sample:
5 300x50x127-190x15
2A 60 J7 V



Grinding wheel 7

D x T x H - P x F / G

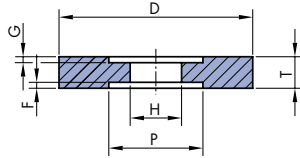

D	T	H	P	F
100	10 to 32	25, 32, 40		60
125	10 to 32	25, 32, 40, 50.8		75
150	10 to 32	25, 32, 40, 50.8		75
200	10 to 40	25, 32, 40, 50.8		110
225	20 to 40	25, 32, 40, 50.8		110
250	10 to 40	40, 50.8, 76.2		130
300	40, 50	127		190
350	40, 50	127		215
400	40, 50, 63, 80, 100	127		215
450	40, 50, 63, 80, 100	127		215
		203.2		290
500	40, 50, 63, 80, 100	203.2		290
		304.8		390
600	50, 63, 80, 100	203.2		290
	50, 63, 80, 100, 125	304.8		390
750	80 to 160	304.8		410
900	80 to 160	304.8		410
1000	80 to 160	304.8		410
1060	80 to 160	304.8		410
1250	80 to 160	304.8		410

F = max. T/2

GENERAL RECOMMENDATIONS



Application:

- Steel:** - Universal - multipurpose:
 - Non-hardened steel:
 - Hardened up to 62 HRc:
 - Hardened over 62 HRc:
 - High-speed steels (HSS)
 - Stainless steels - austenitic
 - martensite



Hard metals: - Tungsten carbides



Casting: - Gray cast iron

- Timed and nodular iron
- Steel cast iron



Non-ferrous metals: - Al and Alloy
 - Cu and Alloy



Non-metals: - Plastic materials
 - Rubber

Quality class/Specification

	STANDARD	EXTRA
Steel: - Universal - multipurpose:		
- Non-hardened steel:	52A60 K7V	
- Hardened up to 62 HRc:	2A80 J8V	3LA80 J8V
- Hardened over 62 HRc:	8A60 I7V	03B91 N5V
- High-speed steels (HSS)	8A60 I7V	03B91 N5V
- Stainless steels - austenitic	C80 I8V	
- martensite	2A80 I8V	
Hard metals: - Tungsten carbides	C80 I8V	
Casting: - Gray cast iron	C46 I6V, C60 J7V	
- Timed and nodular iron	9C46 I6V, 9C60 J7V	
- Steel cast iron	52A36 J6V, 2A80 J8V	
Non-ferrous metals: - Al and Alloy	9C46 H10/3VW	
- Cu and Alloy	9C46 H10/3VW	
Non-metals: - Plastic materials	9C46 H12V, 2A36 FG13/1V	
- Rubber	9C46 G13V, 2A46 I13/2V	



Grinding wheel 1

D x T x H

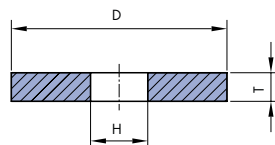

D	T	H
100	10 to 102	10, 13, 16, 20, 25, 32
125	10 to 102	13, 16, 20, 25, 32, 40
150	10 to 152	13, 16, 20, 25, 32, 40
200	10 to 152	13, 16, 20, 25, 32, 40, 50.8
225	10 to 152	16, 20, 25, 32, 40, 50, 60
250	10 to 152	20, 25, 32, 40, 50.8, 76.2
300	10 to 152	32, 40, 50.8, 76.2, 127
350	10 to 152	32, 40, 50.8, 76.2, 127, 152.4
400	10 to 203	40, 50.8, 76.2, 127, 152.4, 203
450	10 to 254	76.2, 127, 152.4, 203, 254, 305
500	20 to 254	127, 152.4, 203, 254, 305
600	20 to 254	127, 152.4, 203, 305

Grinding wheel 5

D x T x H - P x F

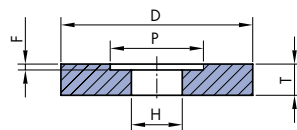

D	T	H	P	F
100	10 to 102	16, 20, 25, 32, 40	60	
125	10 to 102	25, 32, 40, 50.8	75	
150	10 to 152	25, 32, 40, 50.8	75	
200	10 to 152	25, 32, 40, 50.8	110	
225	10 to 152	25, 32, 40, 50.8	110	
250	10 to 152	32, 40, 50.8, 76.2, 100	130	
300	10 to 152	32, 40, 50.8, 76.2, 127	190	
350	10 to 152	76.2, 127, 152.4	215	
400	10 to 203	127, 152.4, 203	230	
450	10 to 254	127, 203, 254, 305	290	
500	20 to 254	152.4, 203, 305	290	
600	20 to 254	152.4, 203, 305	290	

F = max. T/2

Order printout sample:
5 300x50x127-190x20
2A60 J7V

Products of other dimensions can be made to special order.

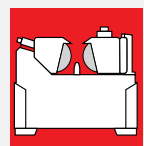

Grinding wheel 7

D x T x H - P x F / G

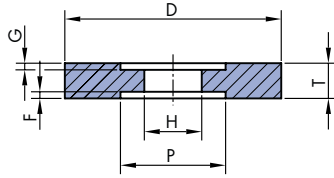

D	T	H	P	F,G
100	10 to 102	16, 20, 25, 32, 40	60	
125	10 to 102	25, 32, 40, 50.8	75	
150	10 to 152	25, 32, 40, 50.8	75	
200	10 to 152	25, 32, 40, 50.8	110	
225	10 to 152	25, 32, 40, 50.8	110	
250	10 to 152	32, 40, 50.8, 76.2, 100	130	
300	10 to 152	32, 40, 50.8, 76.2, 127	190	
350	10 to 152	76.2, 127, 152.4	215	
400	10 to 203	127, 152.4, 203	230	
450	10 to 203	127, 203, 254, 305	290	
500	20 to 254	152.4, 203, 305	290	
600	20 to 254	152.4, 203, 305	290	

F+G = max. T/2

GENERAL RECOMMENDATIONS



Application:

- Steel:**
- Universal - multipurpose
 - Non-hardened steel:
 - Hardened up to 62 HRc:
 - Hardened over 62 HRc:
 - High-speed steels (HSS)
 - Stainless steels - austenitic
 - martensite



Hard metals:

- Tungsten carbides



Casting:

- Gray cast iron
- Timed and nodular iron
- Steel cast iron



Non-ferrous metals

- Al and Alloy
- Cu and Alloy



Non-metals:

- Plastic materials
- Rubber

Quality class/Material

STANDARD	EXTRA	SUPERABRAZIV
4A 60 K7V	3LA80 J8V	
2A80 J8V		03B91N5V
8A60 I7V		03B91N5V
8A60 I7V		
C80 I8V		
2A80 I8V		
C80 I8V		01D126P4V
C46 I6V, C60 J7V		
9C46 I6V, 9C60 J7V		
52A36 J6V, 2A80 J8V		
9C46H10/3V		
9C46H10/3V		
9C46 H12V, 2A36 FG13/1V		
9C46 G13V, 2A46 I13/2V		

CONTROL WHEELS

Witrified bond	Resin bond
A80QV	3A80-100 T7B

For in feed centreless grinding, grit that is two degrees finer should be used.

Grinding wheel 1NA

D x T x H

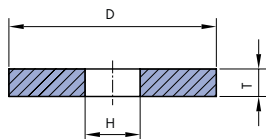

D	T	H
250	3,2 to 8	155
350	8 to 30	160, 230
400	8 to 80	160, 203
500	8 to 30	203, 254

D	T	H
350	62 to 104	160
400	84 to 104	160
450	62 to 104	203

Single profile thread grinding wheels

T = 6 to 16 mm (T ~ 0,03D)

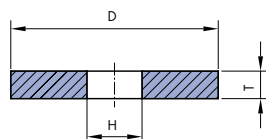

Thread profile size		General recommendations	
Metric (mm)	Whitworth thread no. per 1"	Hardened HSS and tool steels up to 62 Hrc	Hardened HSS and tool steels up to 65 Hrc
0.3-0.8	40-30	2A320 J 10V	C360 E12/6V
0.8-1.25	30-20	2A240 J 10 V	C320 EF12/6V
1.25-1.5	20-18	2A220 J 10V	C280 F12/6V
1.5-2.0	18-14	2A180 J10 V	C240 FG12/6V
2.25-3.0	12-9	2A150 J10 V	C180 G12/6V
3.5-6.0	7-3	2A120 J9 V	C180 G12/6V

Multiprofile thread grinding wheels

T = 20 to 104 mm

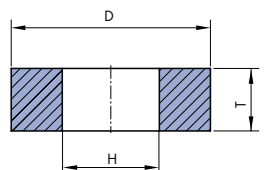

Thread profile size		General recommendations	
Metric (mm)	Whitworth thread no. per 1"	Hardened HSS and tool steels up to 65 Hrc	Hardened HSS and tool steels up to 62 Hrc
0.3-0.8	40-30	C360 D12/6V	2A400 H10V
0.8-1.25	30-20	C320 DE12/6V	2A320 H10V
1.25-1.5	20-18	C280 E12/6V	2A240 H10V
1.5-2.0	18-14	C240 EF12/6V	2A220 H10V
2.25-3.0	12-9	C180 F12/6V	2A180 H10V

Order printout sample:
1NA 350x104x160
2A180J10VL

Products of other dimensions can be made to special order.

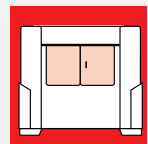

Grinding wheel 1Z
REISHAUER system
 D x T x H - M

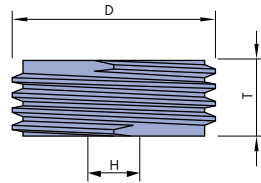

Order printout sample:
 1Z 350x80x160 - M3
 82A100H10V

D	T	H
300	62 to 104	160
350	62 to 104	160
400	84 to 104	160
450	62 to 104	203

GENERAL RECOMMENDATIONS

Dimensions (mm)	Module	Quality class/Specification	
		STANDARD	EXTRA
300 x 145 x 160	1-3 3-6	2A 120 J9V3	3GA 120i9V
300 x 145 x 160		2A 90 J11V	3GA 90i11V
300 x 145 x 160	1,75	82A 220 H10V	3GA 220H10V
104 350 x 84 x 160 62	2-2,75	82A 180 H10V	3GA 180H10V
	3-3,75	82A 150 I10V	3GA 150i10V
	4-6	82A 120 I9V	3GA 120i9V
	over 5-7	82A 100 J9V	3GA 100i9V
104 400 x 84 x 160	1,75	82A 180 H10V	3GA 180i10V
	2-2,75	82A 150 I10V	3GA 150i10V
	3-5	82A 120 I9V	3GA 120i9V
	over 5-7	82A 100 J9V	3GA 100i9V
	over 7	82A 90 J8V	3GA 90i9V

Grinding wheel 4N

NILES System

D x T/U x H x V°

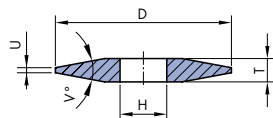

D	T	U	H	V
250	13	3	51	30°, 40°
250	16	4	51	30°, 40°
250	20	4	51	30°, 40°
300	25	4	90	30°, 40°
350	32	5	90, 127	30°, 40°
	32	4	127, 160	
400	40	4	127, 160	40°
	50	4	127, 160	

Applications	Diameter D(mm)	Module 0,75-2	Module 2,5-4	Module over4
100	250			2A54K7V
125	350	2A100 I9V	2A60J7V	2A54J7V
150	400			2A46j6V
Hardened tool steel, high-alloy steels, High-speed steels (HSS) up to 63 Hrc	250-400	82A100I10/6V 3GA100J9V	82A70 I9V 3GA70 I9/6V	82A54I8/6V 3GA54I8/6V
Nitrided steels up to 65 HRc	250-350	C100I9V	C80 I7V	C60 I9/6V

Grinding wheel 12M

MAAG System

D / J x T / U x H - W x E x K

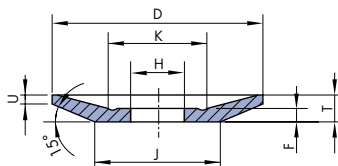

D	J	K	K1	H	F	N	T	U	R1	R2
220	120	80	140	40	8	2,2	18	2, 3, 4, 6	8	6
280	120	80	140	40	8	7	25	4,8	8	6
340	120	80	180	40	8	7	25	4,8	8	6

Area use	Diameter D (mm)	Modul 1-1,5	Modul 1,5-2,5	Modul 2,5-5	Modul bigger to 5
Tempered steel up to 60 HRc	220-280 >340	42A100 K7V	42A80 J7V	42A60 K7V 42A80 I7V	42A46 J7V 42A46 I7V
High-speed steels (HSS) hardened up to 64 HRc	220-280 >340	2A100 J7V	2A80 I7V	2A60 I7V 2A60 H7V	2A46 I7V 2A46 H7V
Tool steel up to 64 HRc	220-280 >340	8A80 I7V	8A80 I7V	8A60 H7V 8A60 H7V	8A46 I7V 8A46 H7V
Nitrided steel up to 65 HRc	220-280 >340	C100 I7V	C80 I7V	C60 J6V C60 J6V	C60 J6V C60 J8V

Order printout sample:

12M 220/120x18/2x40-6x16x140

2A 100J7V

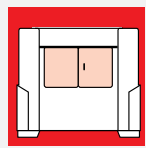

Grinding wheel 3K1
KLINGELNBERG System
 D/J x T/U x H

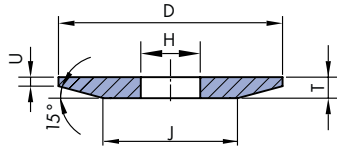

D	J	K	T	U	2R	G	V°	H
250	170	110	14	3	10	5	15°	30, 32, 35, 40, 50
250	180	110	17	5	10	5	15°	30, 32, 35, 40, 50
250	190	110	22	8	10	5	15°	30, 32, 35, 40, 50

Grinding wheel 3K2
 D/J x T/U x H-Px F

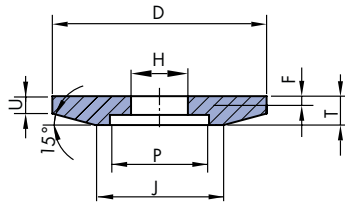

D	J	K	T	U	P	2R	G	V°	H
250	170	110	14	3	100	10	5	15°	30, 32, 35, 40, 50
250	180	110	17	5	100	10	5	15°	30, 32, 35, 40, 50
250	190	110	22	8	100	10	5	15°	30, 32, 35, 40, 50

Order printout sample:
 3K2 250/110x14/3x32
 3LA60H7V

Products of other dimensions can be made to special order.



Grinding wheel 1
D x T x H

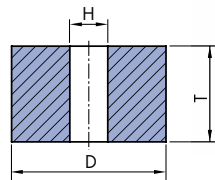

D	T	H
6	6, 10, 13	2,5 3
8	8, 10, 16	2,5 3
10	6, 10, 13, 20	3, 4
13	6, 13, 20	3, 6
16	6, 10, 16	6,
20	13, 20, 25, 32	6, 8
25	13, 20, 25, 32, 40	6, 8, 10
32	13, 20, 25, 32, 40	6, 8, 10, 13
40	13, 20, 25, 32, 40	6, 10, 13, 16
50	13, 20, 25, 32, 40	10, 13, 16, 20
63	13, 20, 25, 32, 40	13, 16, 20
80	13, 20, 25, 32, 40	16, 20, 25
100	16, 25, 32, 40, 50	16, 20, 25

Grinding wheel 5
D x T x H - P x F

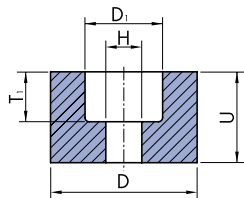

D	T	H	P	F
16	10, 16	6	10	
20	13, 20	6, 8	13	
25	10, 16, 25	6, 8, 10	16	
32	16, 20, 25, 32	8, 10, 13	20	
40	20, 25, 32, 40	10, 13	25	
50	20, 25, 32, 40	16, 20	32	
63	25, 32, 40, 50	16, 20	32	
80	40, 50, 63	20, 25	40	
100	32, 40, 50	20, 25, 32	52	

F = max. T/2

Order printout sample:
5 40x25x10-25x12
3 LA80J8VL

Products of other dimensions can be made to special order.

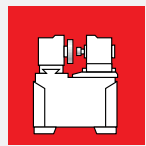

CBN-V grinding wheel 1A1

D x T x X x H

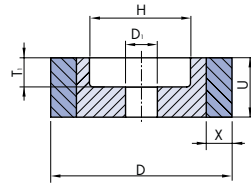

D	U	X	H	D ₁	T ₁
20	10 - 20	3	6/8/10	12	max. U/2
22	8	3	8	12	
25	10 - 25	3/5	6/8/10/12.7/13	13 - 18	
30	10 - 25	3/5	8/10/12.7/13	16 - 22	
35	10 - 25	3/5	8/10/12.7/13	20 - 28	
40	10 - 25	3/5/8	8/10/12.7/13	20 - 32	
45	10 - 25	7.5	8/10/12.7/13	20 - 28	
50	10 - 25	3/5	6/8/10/13/20	30 - 40	
60	10 - 25	3/5	20	30 - 45	
75	10 - 25	3/5	20	30 - 50	

CBN-V grinding wheel 1A8

D x T x H - P x F

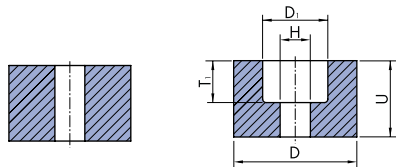

D	U	H	D ₁	T ₁
8	8 - 15	3/4	As per agreement	Max. U/2
9	8 - 15	3/4		
10	8 - 16	3/4		
12	8 - 16	3/4		
13	8 - 16	4/5		
14	8 - 16	4/5/6		
16	8 - 20	4/5/6		
17	8 - 20	4/5/6		
18	8 - 20	4/5/6		

GENERAL RECOMMENDATIONS



Steel



Hard metals



Non-ferrous metals



Castings:



Non-hardened steel

Applications	Quality class/Specification	
	STANDARD	EXTRA
Universal	3LA80JKV	
Non-hardened steel:	4A60KV	
Hardened up to 62 HRc	2A60JV, GA60JV	B126V
Hardened over 62 HRc	3LA80JKV, 3GA60KV,8A60IV	B126V
High-speed steels (HSS)	62A8JV	B126V
Stainless steel	2A60JV	
Bearings	82A80KLV, 82A100KV	B107V
Hard metals	Tungsten carbides C80IV	
Non-ferrous metals	Al, Cu C 60JV	
Castings:	Gray, ductile 3A20OB12, 53C24QB	
Non-hardened steel	Plastic materials C60V	

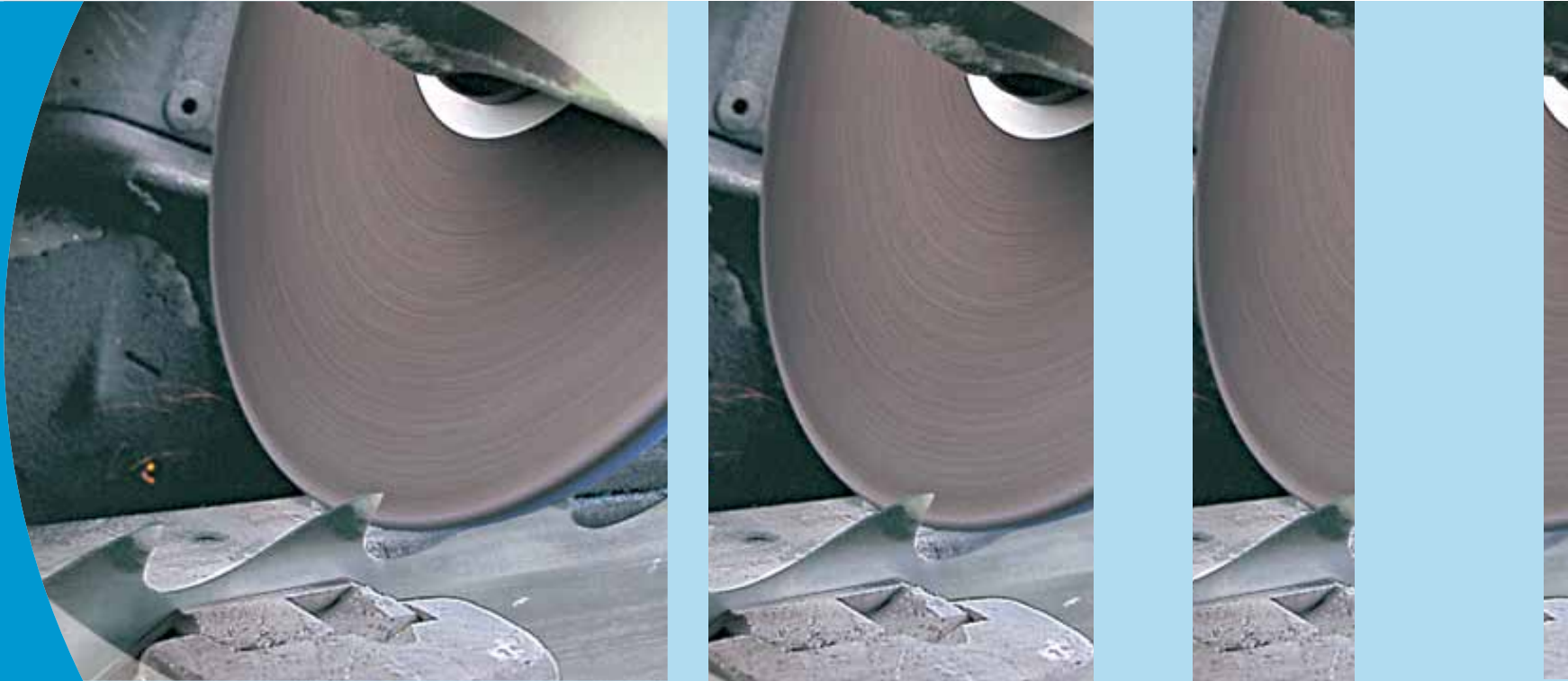



Grinding wheel 1

D x T x H

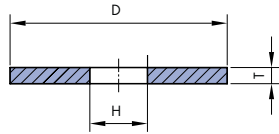

D	T	H
80	0,8 to 13	10, 13
100	1 to 20	13, 20
125	1 to 20	20
150	1 to 20	20, 32
175	1,5 to 20	20, 32
200	1,5 to 20	20, 32
250	1,5 to 20	20, 32, 50.8

Grinding wheel 1- ..

D x T x H

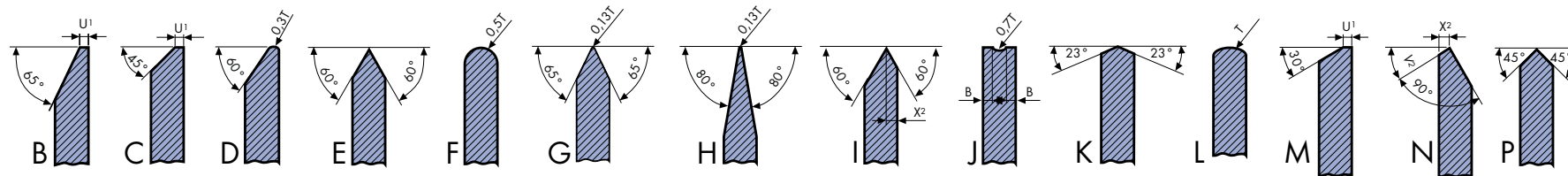

D	T	H
100	1 to 4	10, 13, 20
125	1 to 5	16, 20
150	2 to 13	20
175	2 to 13	20
200	2 to 16	20, 32
225	2,5 to 16	20, 32
250	4 to 20	20, 32
300	6 to 25	32, 40

Order printout sample:
1-B 200x8x20
4A60M/2A60K5V

Products of other dimensions can be made to special order.



Grinding wheel 3

D / J x T / U x H

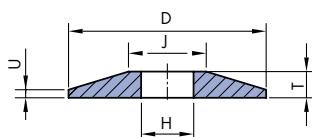

D	J	T	U	H
80	40	5	1	13
100	50	6	1,5	20
125	63	8	2	20, 32
150	75	8	2	20, 32
175	85	10	3	20, 32
200	100	13	3	20, 32
250	125	14	3	32

Grinding wheel 4

D / J x T / U x H

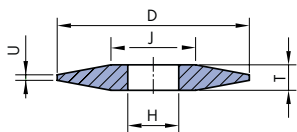

D	J	T	U	H
80	40	8	2	13
100	50	10	2	20
125	63	10	2	20, 32
150	75	13	2	20, 32
175	85	13	3	20, 32
200	100	16	3	20, 32
250	125	20	4	32

Grinding wheel 12

D / J x T / U x H - W x E x K

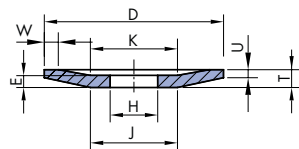

D	J	T	U	H	W	E	K
50	25	10	2	13	4	6	25
80	31	10	2.5	13	4	6	31
100	36	13	3.2	20	5	7	36
125	61	13	3.2	20	6	7	61
150	66	16	3.2	20	8	9	66
175	78	18	3.2	20	9	10	78
200	90	20	3.2	20, 32	10	10	90
250	140	22	4	32	12	12	140

Order printout sample:

12 80/31x10/2,5x13-4x6x31

2A46/3M7V

Products of other dimensions can be made to special order.



Grinding wheel 12B

D x T x H - U x J x E

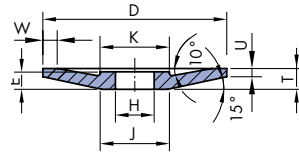

D	T	H	U	J=K	E
80	8	20	2	30	6
100	12	20	3	35	8
125	14	20	3	40	9
150	15	20	3	50	10
175	18	20	3	60	11
200	19	20, 32	3	70	12
250	21	32	3	100	13

Grinding wheel 5

D x T x H - P x F

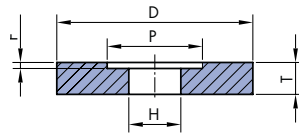

D	T	H	P	F,G
250	10 do 32	51, 76	130	F+G = max. T/2
300	13 do 50	76, 127	190	
350	16 do 50	76, 127	215	
400	20 do 80	127, 152.4	230	
450	20 do 80	127, 152.4	290	
500	25 do 100	127, 152.4	290	
600	32 do 100	127, 152.4	290	

Grinding cup 6

D x T x H - W x E

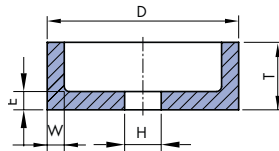

D	T	H	W	E
50	32	13	5	8
80	40	20	6	10
100	50	20	8	10
125	63	20	8	13
150	80	20	10	16
175	100	32	15	20
200	100	32	20	25
250	100	76	20	25

Order printout sample:

6 150x80x20-10x16

2A60K7VRL

Grinding cup 11

D / J x T x H - W x E x K

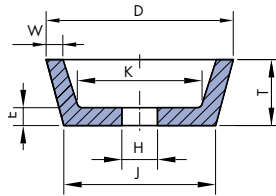

D	J	T	H	W	E	K
50	27	32	13	4	8	22
80	57	32	13	6	8	46
100	71	40	20	8	10	56
125	96	40	20	10	10	81
150	114	45	20	10	13	96
175	135	45	32	12,5	15	120
200	155	50	32	20	20	140
250	200	60	76	30	20	180

GENERAL RECOMMENDATIONS

Work piece	Manual grinding	Mechanical grinding	
Turning cutters Tool steel High-speed steel (HSS) Tungsten carbides	2A60K7V	2A60J8V, 3GA60J8V	
	4A60K7V	62A60J8V, 3GA60J8V	
	C60K6V	C60K6V	
Spiral drills Tool steel High-speed steel (HSS) Tungsten carbides	Profiling	Sharpening	
	2A60M8V	2A100L8V, 3LA120I6V	
	82A60J6V	2A100L8V, 3LA120I6V	
	C60J6V	C80J7VL	
Cutters, drills Tool steel High-speed steel (HSS) Tungsten carbides	Profiling	Sharpening	
	82A46/3J6V, 82A100I8V	2A46/1H9/0V, 22A46H10/0V	
	82A46/3J6V, 82A100I8V	2A46/1H9/0V, 22A46H10/0V	
	C60K6V	C60J7V	
Pull and push broaches	High-speed steel (HSS)	3GA70/3K5V	
Planing knives Wood working Printing works	Profiling	Sharpening	
	2A30/1J7V, 42A46G8B	2A80I12/2SV, 42A60G8B	
	2A30/1J7V, 42A46G8B	2A80I12/2SV, 42A60G8B	
Saw sharpening Circular saws (HSS) - tool steel Circular saws (Stellite) Band saws (HSS) Band saws (Stellite) Chain saws (HSS) Band-block saw (HSS)	Profiling	Sharpening	Grinding of tooth flank
	11A60/3L7V, 2A46/3M6V, 3GA46/2K5V12R2, 40A60N/22A60L5V	3GA60/3M6V, 4A46/3M6V	4A60M7VR, 2A60K7VR
	A60/3M7V	2A60/3L7V13	4A60M7VR, 2A60K7VR
	3GA60/3N5V, 2A46/3M5V	3GA60/3N5V, 2A46/3M5V	
	4A46M/22A46K5V	2A60/3K7V13R	4A60M7VR, 2A60K7VR
	4A60M6V		
	3GA46/3O5V, 2A46/3N5VRL	3GA60/3O5VR, 2A46/3N5VR	4A60M7VR, 2A60K7VR

Use finer and harder grinding wheels for sharpening narrow band saws and fine-toothed circular saws.

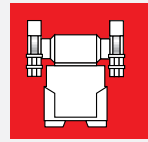

Grinding wheel 1

D x T x H

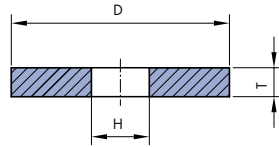





D	T	H	
125	20	12.7, 16, 20, 25, 32, 40	W*
150	20	12.7, 16, 20, 25, 32, 40	W*
175	20	16, 20, 25, 32, 40	W*
200	20, 25	16, 20, 25, 32, 40	W*
250	20, 25	16, 20, 25, 32, 40	W*
300	30, 40	30, 40	
350	40	30, 40	
400	40, 50	40	

Order printout sample:
1 300x30x127
C60K6V

W*- R16 includes reducer rings 12.7, 16, 20, 25, 32

GENERAL RECOMMENDATIONS

Work piece		Specification	
		Coarse grinding	Finishing
 Steels	Non-alloyed	A36P5V	A60M6V
	Alloyed	2A46M5V	2A60K6V
	High-alloyed	4A60M7V	4A60K6V
 Hard metals	Tungsten carbides	C60K6V, A30P7V	C80K6V
 Casting	Gray	9C46M6V, 30A24P4V	
	Steel	7A36M5V	
	Nodular	54A36L5V	
 Non-ferrous metals	Al and alloys	9C46K7V	
	Cu and alloys	9C46K7V	
 Non-metals	Plastic materials	9C46J8V	
	Ceramics	9C46J8V	



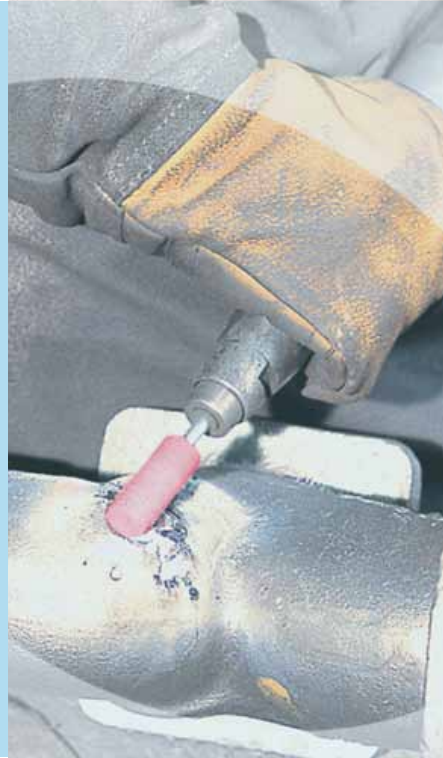



Mounted points 52A

D x T - S x L

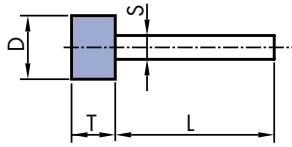

D	T	S	L
3	3	3	30
6	6	3	30
10	6	3	30
10	10	3	30
13	6	3	30
13	10	3	30
13	13	3	30
10	6	6	40
10	10	6	40
13	6	6	40
13	10	6	40
13	13	6	40
16	6	6	40
16	8	6	40
16	10	6	40
16	13	6	40
16	16	6	40
20	4	6	40
20	6	6	40
20	10	6	40
20	12	6	40
20	20	6	40
25	6	6	40
25	10	6	40
25	13	6	40
25	20	6	40
25	25	6	40
32	10	6	40
32	13	6	40
32	16	6	40
32	20	6	40
32	25	6	40
32	32	6	40
40	10	6	40
40	13	6	40
40	20	6	40
40	25	6	40
40	30	6	40
40	40	6	40
50	10	6	40
50	13	6	40
50	20	6	40
50	25	6	40
40	40	8	40
50	20	8	40
50	25	8	40
60	30	8	40
30	30	9	36
50	20	9	40

Order printout sample:
52A 40x20-8x40
52B 4A60/4O6V



Mounted point 52B

D x T - S x L

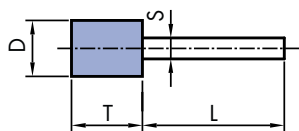

D	T	S	L
3	5	3	30
3	6	3	30
4	6	3	30
4	8	3	30
5	6	3	30
5	10	3	30
6	8	3	30
6	10	3	30
6	12	3	30
8	13	3	30
10	12	3	30
10	20	3	30
13	20	3	30
3	6	6	40
4	8	6	40
5	10	6	40
6	8	6	40
6	12	6	40
8	10	6	40
8	13	6	40
8	15	6	40
8	20	6	40
10	13	6	40
10	20	6	40
10	25	6	40
10	30	6	40
10	32	6	40

D	T	S	L
13	16	6	40
13	20	6	40
13	25	6	40
13	40	6	40
16	20	6	40
16	25	6	40
16	32	6	40
16	40	6	40
16	50	6	40
20	25	6	40
20	32	6	40
20	40	6	40
20	50	6	40
25	32	6	40
25	40	6	40
25	50	6	40
32	40	6	40
32	50	6	40
25	32	8	40
32	40	8	40

Mounted point 52C

D x T - S x L

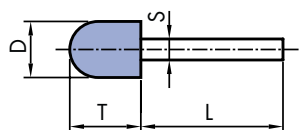

D	T	S	L
3	6	3	30
6	10	3	30
8	16	3	30
13	13	3	30
6	20	6	40
8	16	6	40
12	20	6	40
13	13	6	40
20	25	6	40
20	40	6	40

Order printout sample:
52C 13x13-3x30
52D 2A60/4P6V



Mounted point 52D

D x T - S x L

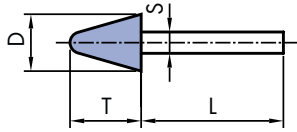

D	T	S	L
6	10	3	30
10	10	3	30
10	12	3	30
10	20	6	40
13	13	6	40
16	16	6	40
16	32	6	40
16	45	6	40
20	20	6	40
20	25	6	40
20	32	6	40
20	40	6	40
20	45	6	40
20	63	6	40
25	25	6	40
25	32	6	40
25	70	6	40
32	32	6	40

Mounted point 52E

D x T - S x L

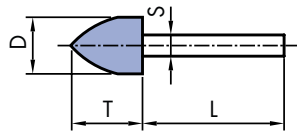

D	T	S	L
3	5	3	30
5	10	3	30
8	15	3	30
12	20	3	30
3	6	6	40
5	10	6	40
8	15	6	40
10	20	6	40
12	20	6	40
20	32	6	40
20	40	6	40
20	50	6	40
20	60	6	40
22	50	6	40
22	70	6	40
32	50	6	40

Order printout sample:
 52E 32x50-6x40
 54 A46P4VL



Mounted point 52F

D x T - S x L

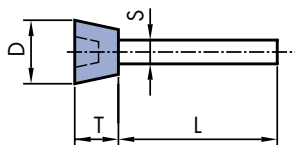

D	T	S	L
20	16	6	40
25	16	6	40
25	20	6	40
32	25	6	40

Mounted point 52G

D x T - S x L

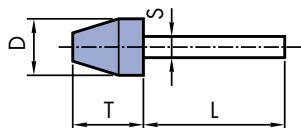

D	T	S	L
13	16	6	40
16	20	6	40
20	25	6	40
20	63	6	40
25	32	6	40
32	40	6	40

Mounted point 52H

D - S x L

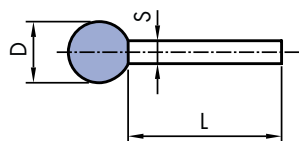

D	S	L
4	3	30
6	3	30
8	3	30
3	6	40
6	6	40
8	6	40
10	6	40
13	6	40
15	6	40
20	6	40
25	6	40
32	6	40
40	6	40
40	8	40
60	9	40

Mounted point 52N

D x T - S x L

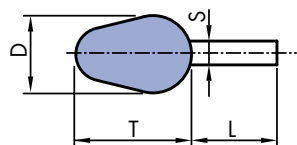

D	T	S	L
20	25	6	40





Order printout sample:

52N 20x25-6x40

54A 4A60/4O6V



GENERAL RECOMMENDATIONS

Ground material		Specification										
		3A-B	A-V	4A-V	4A-V	2A-V	2A-V	6A-V	LA-V	GA-V	54A-V	C-V
			O	N	P	L	O	N	M	N	P	M
 STEELS	Universal			***	**	**	**		**	**		
	Non-alloyed		***	*	**		**			**		
	Tool		**	**				**	***	**		
	HSS					**			*			
	Stainless					***		*	**			
 HARD METALS	Carbides											***
	Stellite											
 ALLOYS	Universal	***			**							
	Steel		**	**		**	*	***		**	**	
	Alloyed				*		*				***	
	Gray										***	**
	Nodular		*								***	
 NON FERROUS	Aluminium											***
	Copper											**
	Bronze											**
 OTHER	Plastic					**						***
	Rubber					**						***

*** Most suitable, ** Medium suitable, * Satisfactory

Selection of grit size depending on point diameter



Diameter D (mm)	Grit size	
	Coarse	Fine
up to 4	/	120
from 5 to 7	60	100
from 8 to 14	46	80
from 15 to 30	36	60
over 32	24	36





Files 90PR

B x C x L

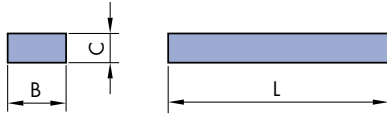

B	C	L
6	3	100
10	5	100
12	6	150
15	7.5	150
20	10	200
40	20	125
50	25	150
50	25	175
50	25	200
50	25	250

Files 90KB

B x C x L

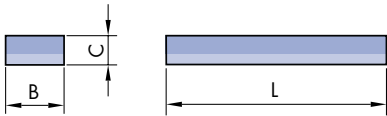

B	C	L
6	3	100
10	5	100
12	6	150
15	7.5	150
20	10	200
40	20	125



Files 90KV

B x L

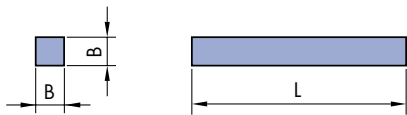

B	L
6	100
8	100
10	100
10	150
15	100
15	150
20	200
25	200

Order printout sample:
90KV 13x150
C 180V



File 90TR

B x L

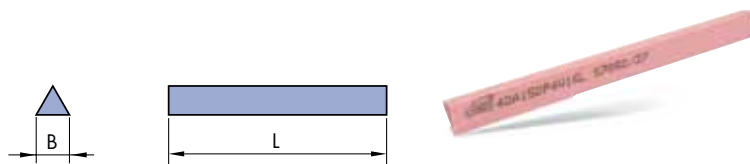

B	L
6	100
8	100
10	100
10	150
15	100
15	150
20	200

File 90OK

D x L



D	L
6	100
8	100
10	100
10	150
15	100
15	150
20	200

File 90PO

D x L

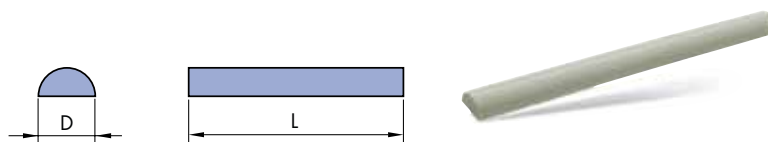

D	L
6	100
8	100
10	100
10	150
15	100
15	150
20	200

Order printout sample:
90PO 15x150
C 180V



File 90DL

B x C/C1 x L

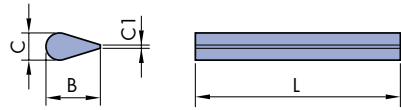

B	C	C1	L
25	6	1	100
25	6	1	150
45	10	1	100
45	10	3	100
45	10	2	120

File 90NO

B x C x L

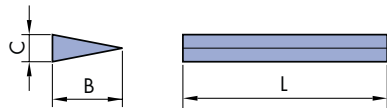

B	C	L
25	3	100
25	6	100
45	10	100

File 90RO

B x C x L



B	C	L
20	10	150
15	6	150
14	5	150

Order printout sample:
 90RO 20x10x150
 1 C240V



File 90BK

B x C x L

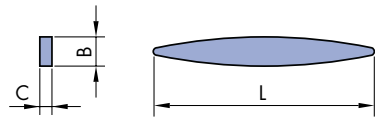

B	C	L
35	13	230

File 90RPZ

B x L

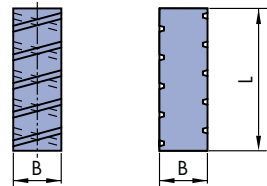

B	L
50	150

File 90RPR

B x C x L

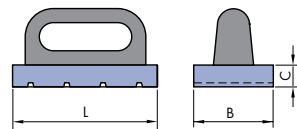

B	C	L
80	25	150

Order printout sample:

90RPR 80x25x150

9C20V



	Applications	Specification		
		Coarse	Medium	Fine
Steel	Manual grinding - for Steel	2A80V	2A220V	2A400V
		4A120V	4A220V	4A400V
		C120V	1C220V	1C400V
	Dressing of grinding wheels	9C16V, 9C24V	9C60V	9C120V
		9C30V, 9C36V	9C80V	
	Opening of diamond tools	2A100I V	2A150HI V	2A320V
			2A220H V	
	Manual grinding PKB structure - bi-layered files	9C120/C320V W*	2A220H V W*	C240/C500 V W*
		C120/C320V	9C150/C320V	
		2A120R/2A320V	2A150/4A320V	4A240/2A400V
		4A120/2A320V		

W* Optional additional impregnation

Applications	Filetype	Quality
Scythe file	90BK	C180V, A180V
Construction file	PKV-F, 90PR-G, 90KV-F	C20V, 9C20V, C30V

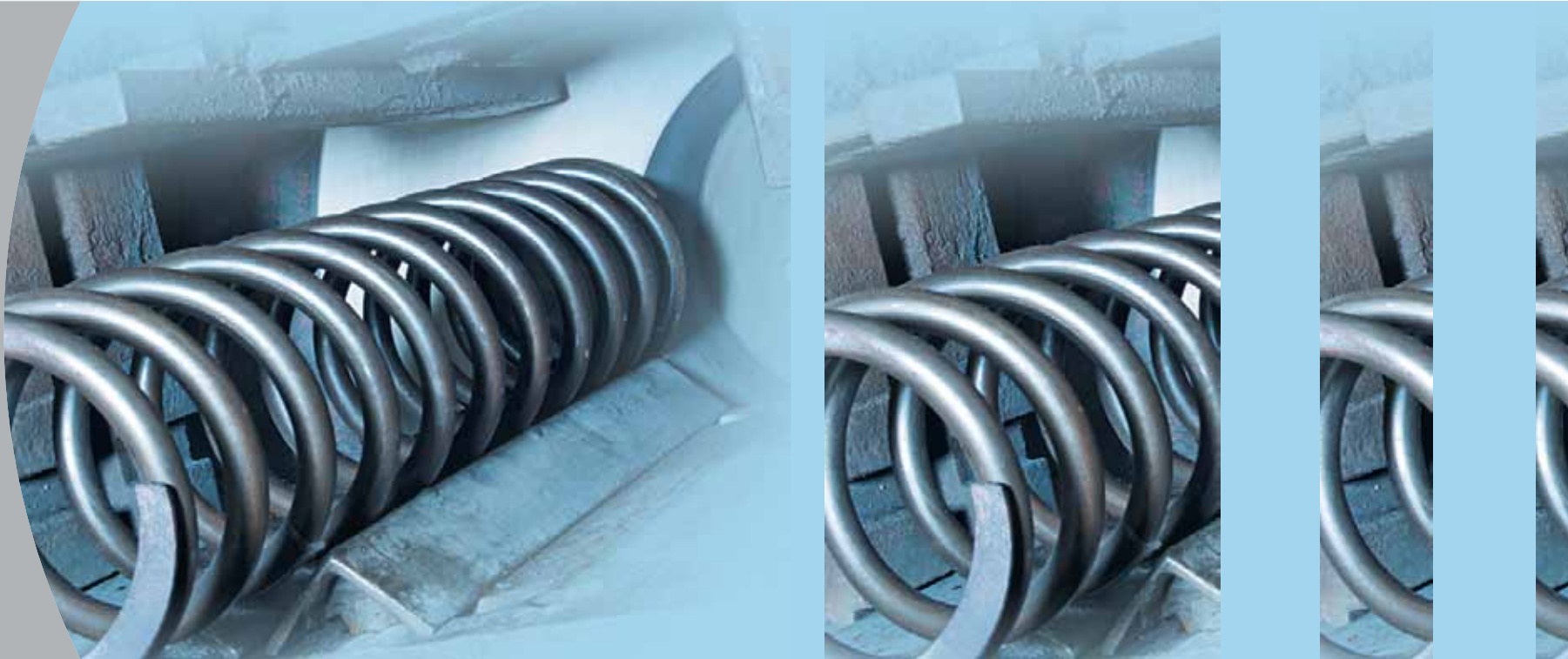



Grinding wheels 35, 36, 36P, ...

D x T x H

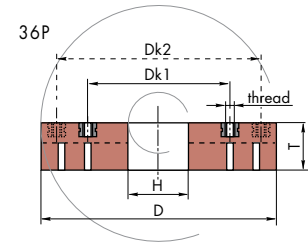
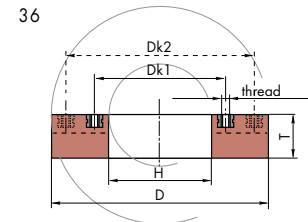
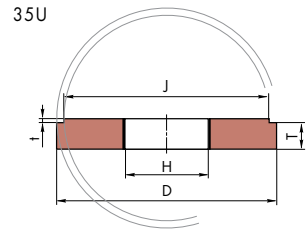

D	T	H
175	50	0
225	50, 52	0, 80
400	50, 60, 65	0, 40, 75, 80, 85, 250
450	60, 80, 90, 100	0, 40, 70, 80, 100, 200, 254
600	75, 80	250, 350
650	80, 90, 100	200, 350
660	80, 90, 100	150, 200, 250
915	120	200

Wire diameter	Carbon steel DIN EN 10270 1-2 (DIN 17223 in DIN 17221)		Stainless steel-EN DIN 10270-3 (DIN 17224)	
	Low spring constant	High spring constant	Low spring constant)	High spring constant
To 1,5 mm	GA 46 M V	GA 46 N B1	GA 46 M V	GA 36 O B3
To 3 mm	GA 30 N B1	GA 30 O B1	GA 24 L B3	GA24 O B3
To 6 mm	GA20 NO B1	GA20 Q B1	GA 20 K B3	GA 20 M B3
Up 6 mm	GA16 N B1	GA16 P B1	GA 16 N B3	GA 16 P B3

Order printout sample:
36 450x60x200x15/10
GA 20 M B3

Products of other dimensions can be made to special order.

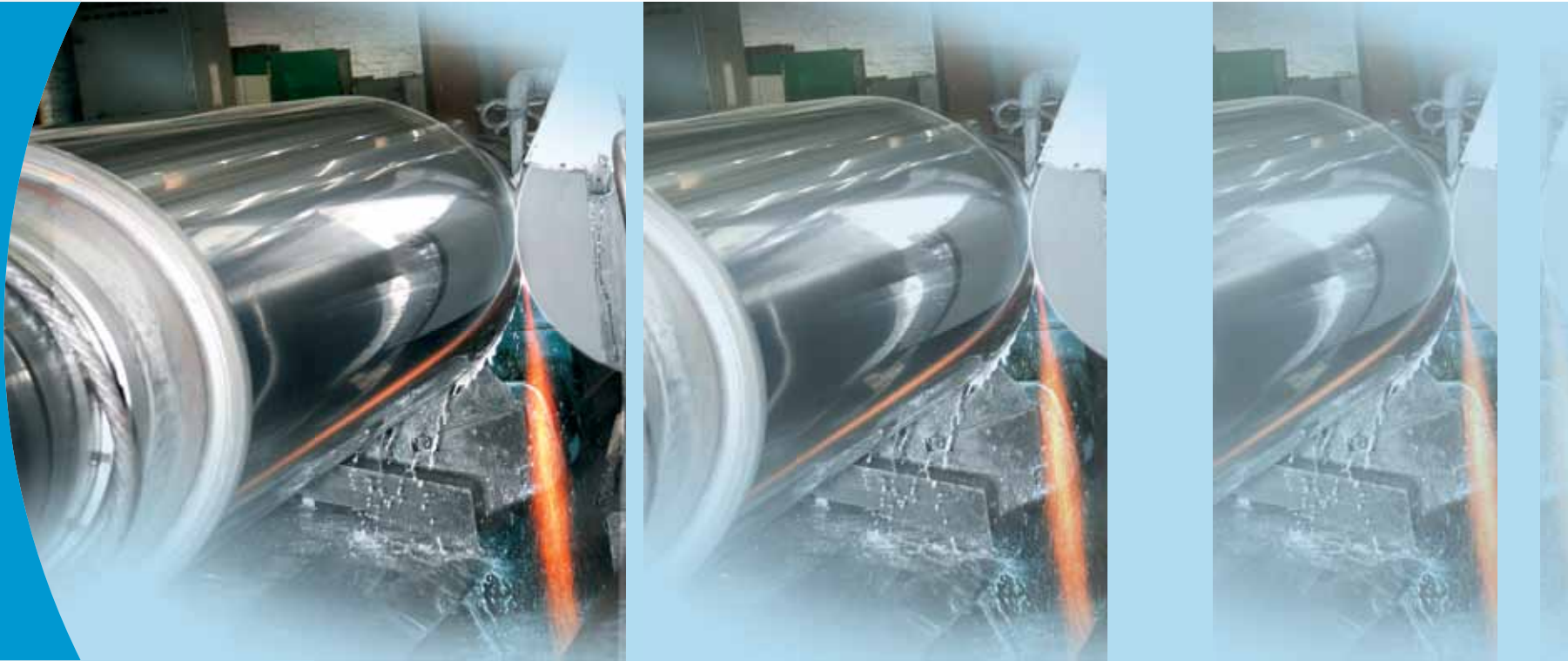



In Swatycomet grinding wheels for grinding of new rolls and renewal of rolls in usage are produced. For final grinding of new rolls we recommend two different granulations, a rough and a fine one, whereby the grits used depend on the size of the grinding wheel. Due to different types of bonds implemented grinding wheels can be used at peripheral speeds from 25 to 63 m/s. For special materials such as ASP and WIDIA we produce tools with CBN and DIAMOND abrasives up to the diameter of 600 mm.

Grinding wheel 1

D x T x H

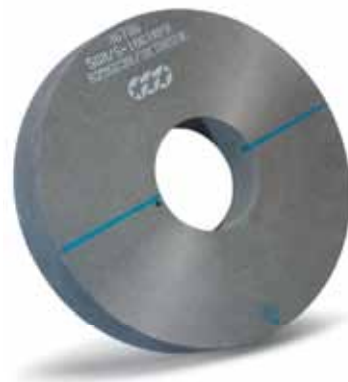
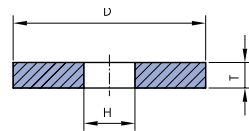

Grinding wheels 5

D x T x H - P x F

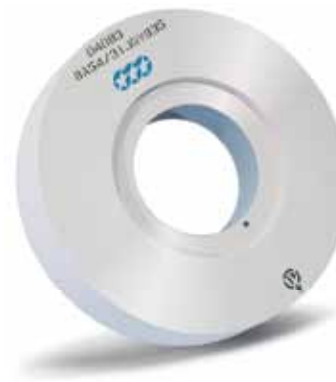
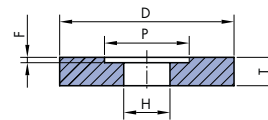

Grinding wheels 7

D x T x H - P x F/G

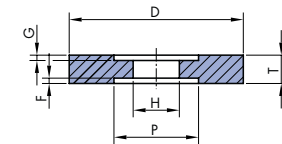

D (mm)	T (mm)	H (mm)
350	38	127
600	50, 60, 70, 100, 125	203.2, 304.8
700	60, 80, 100, 125	304.8
750	80, 100, 125	304.8
762	80, 100, 125	304.8
800	80, 100, 125	304.8, 381
900	80, 100, 150	304.8, 355, 457.2
920	80, 100, 127, 150	304.8, 355, 457.2, 508
1000	60, 75, 80, 100, 127, 150	304.8, 355, 457.2, 508
1065	80, 100, 127	406.4

Machines:
Waldrich, Herkules, Landis, Schaudt, Churchill, Fortuna, Farrel, ...

Order printout sample:
1 900x100x304.8
S29GC36/2J7BX03L



Production of rolls

Casting	Rough grinding	51C16/4R4B18
	Final grinding	C80/3H9V60
Steel	Rough grinding	8A54/3IJ7V835
	Final grinding	C120/1H11V60

Steel production

Hot milling - renewal of rolls

Working rolls	Casting	Rough	Standard	S9C36/2J7BX03
			High stock removal	S29GC36/2J7BX03
		Fine	Standard	S9C36-60K7BX03
			High stock removal	S29GC36-60J7BX03
	Forged rolls	Rough grinding		S2A46/3K7BM03
		Rough grinding		S2A60/3J7BM03
Final grinding		C80/2I7V60		

Cold milling - renewal of rolls

Working rolls	Standard	S2A46/3K7BM03
	High stock removal	S68C36-60 J-B
Back up rolls	Standard	S2A46/3K7BM03

Sendzimir rolls

Thrust bearings	68C60J-B
Back up rolls	68C60J-B
Drive rolls	68C60J-B
Intermediate rolls	68C60J-B
Working rolls	S29GC100/1F10BX03
Working rolls - fine grinding	9C180/9E11BX50/300
Chromium cast rolls	2A60/3J7V
ASP working rolls	102B 46-151R100B47S
WIDIA working rolls	101D 46-151R100B40S

Copper and aluminium mills

Plate	2A60 - 80 H10/3V35 (standard)	8A54 - 60I7V835 (high stock removal)
Sheet	9C150 - 180G-H10/3V35	
Aluminum foil	SC220/1D11BK03L	

Grinding of rubbered rolls

Hard rubber	2A30/1G13/1V
Hard rubber - fine grinding	2A54/1G13/1V
Soft rubber	1A24/1I7+V
Soft rubber - fine grinding	C60/1G13/1V
Calender rolls	8A60/1H8/6V

Products of other dimensions can be made to special order.





Mounted points SGY

D x T x H - V

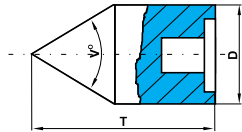

Grinding wheels 36

D x T x H - P x F

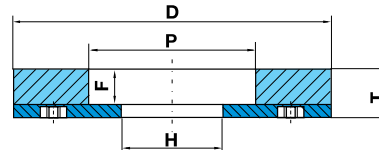

Grinding of threaded center bores in rolls

Type/Dimensions SGY D x T x H - V	Specification
18 x 35	8A120/2L9V835
26 x 38	8A120/2L9V835
50 x 39	8A120/2L9V835

Grinding length

Type / Dimension	Specification
36 D x T x H - P x F	8A36/2J8V835

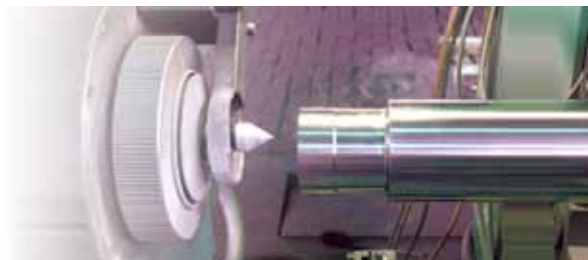

Grinding wheel peripheral speed

Material	Type of Grinding	m/sec	Infeed - mm/feed	Longitudinal feed
Casting	Rough production grinding	45-63	0.25	1000 mm/min
	Fine	35-50	0.010-0.020	5000 mm/min
	Renewal grinding	35-40	0.010-0.030	3000 mm/min
Steel	Rough production grinding	35-63	0.020-0.030	5000 mm/min
	Fine renewal grinding	25-30	0.002-0.005	3000 mm/min

Cooling:

Quantity in l/h	200-600 l/min (depending on the D of the grinding wheel)
Pressure	3-5 bar
Nozzle	Minimal T of grinding wheel x 3 mm

Order printout sample:
SGY 26x38x8-V60
8A80/2L8V835



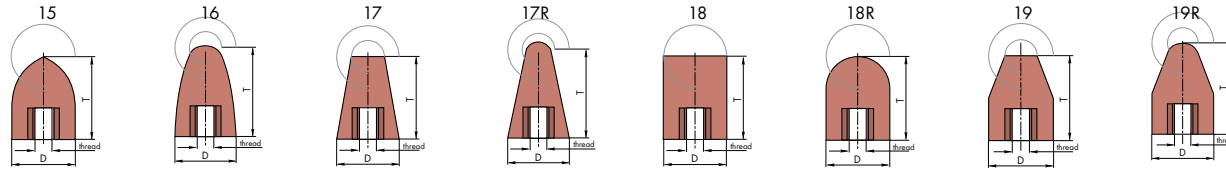

Intended for the CLEANING and GRINDING of casts and metal parts.

Specification	Hardness	Material	Quality class
3A20-36N-Q4B	R	Metals, steel	Standard
53C16-24L-Q4B	R	Stainless steel, casting	Special

Type	Dimensions D x T x thread mm	Peripheral speed m/s	RPM 1/min	Packaging units pz.
15	40 x 63 x thread	50	23900	25
15	50 x 80 x thread		19100	
15	63 x 80 x thread		15200	
16	40 x 63 x thread		23900	
16	50 x 80 x thread		19100	
16	63 x 80 x thread		15200	
17	32 x 60 x thread		30000	
17	40 x 63 x thread		30000	
17	40 x 90 x thread		23900	
17	50 x 100 x thread		19100	
17R	50 x 50 x thread		19100	
17R	63 x 80 x thread		15200	
17R	80 x 100 x thread		12000	
18	32 x 50 x thread		30000	
18	40 x 60 x thread		23900	
18	40 x 80 x thread		23900	
18	50 x 50 x thread		23900	
18	50 x 100 x thread		19100	
18R	40 x 60 x thread		23900	
18R	50 x 50 x thread		19100	
18R	50 x 80 x thread		19100	
18R	50 x 100 x thread		19100	
19	40 x 50 x thread		23900	
19	50 x 80 x thread		19100	

The selected grit size depends on the mounted point diameter:

Ground material	Quality class/Specification	
	STANDARD	EXTRA
Steel	52A20NB	100
Gray, nodular and malleable casting	3A20OB, 9C16PB	*ZA20PB

On customer request, mounted points can also be produced with the following threads:

M10 (3/8"), M12 (1/2"), M14 (5/8"), M16 (3/4")

*Only types 18, 18R



The SPECIAL grinding wheels are intended for specific industry applications.

Advantages:

- high level of quality
- high durability
- no fly-offs during grinding
- exceptional grinding properties
- aggressive material removal
- complies with EN12413, OSA , FEPA



SKORPIO SPECIAL
3STARS SPECIAL

Specification	Material	Quality class	Abrasive grain
ZA24R-BF	Steel, Stainless steel, Casting	Special	ZA
ZA24S-BF	Steel, Stainless steel, Casting	Special	ZA
EZA24S-BF	Steel, Stainless steel, Casting	Special	ZA + Sinter alumina

Type	Dimensions D x T x H mm	Peripheral speed m/s	RPM 1/min	Packaging units pz
27	100 x 4 x 16	80	15300	10
27	100 x 7 x 16		15300	
27	115 x 4 x 22,23		13300	
27	115 x 7 x 22,23		13300	
27	125 x 4 x 22,23		12250	
27	125 x 7 x 22,23		12250	
27	150 x 4 x 22,23		10200	
27	150 x 7 x 22,23		10200	
27	180 x 4 x 22,23		8500	
27	180 x 7 x 22,23		8500	
27 (28)	180 x 8 x 22,23		8500	
27	180 x 10 x 22,23		8500	
27	230 x 4 x 22,23		6650	
27	230 x 7 x 22,23		6650	
27 (28)	230 x 8 x 22,23		6650	
27	230 x 10 x 22,23		6650	



On customer request, grinding wheels can also be produced as type 27-GR and 1AF.



We also manufacture double layer grinding wheels with a thickness (T) of 7 mm.

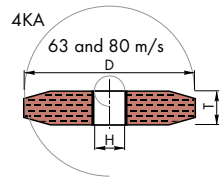
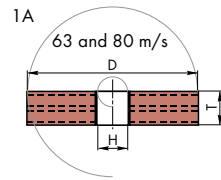
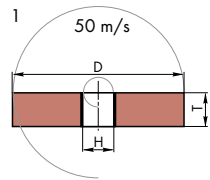

Specification	Hardness	Material	Quality class
3A20-36N-Q4BF	P-R	Steel	Standard
2ZA16-24N-R4BF	P-Q	Cast iron steel	Standard
53C20-36N-R4BF	Q-R	Stainless steel	Special
51C16-240-R4BF	Q-R	Grey cast	Standard



Type	Dimensions D x T x H mm	Peripheral speed m/s	RPM 1/min
1A	50 x 4 to 12 x H	63, 80	24060/30560
1A	60 x 4 to 12 x H	63, 80	19100/25500
1A	65 x 6 to 12 x H	63, 80	18510/23500
1A	70 x 6 to 12 x H	63, 80	16040/21800
1	75 x 20 to 25 x H	50	12750
1A	75 x 6 to 25 x H	63, 80	16100/20400
4KA	75 x 20 to 25 x H	80	20400
1	80 x 20 to 25 x H	50	12000
1A	80 x 4 to 25 x H	63, 80	15100/19100
4KA	80 x 20 to 25 x H	80	19100
1	100 x 15 to 25 x H	50	9550
1A	100 x 6 to 25 x H	63, 80	12100/15300
4KA	100 x 15 to 25 x H	80	15300
1	125 x 15 to 25 x H	50	7650
1A	125 x 15 to 25 x H	63, 80	9650/12250
4KA	125 x 15 to 25 x H	80	12250
1	150 x 20 to 30 x H	50	6400
1A	150 x 20 to 30 x H	63, 80	8050/10200
4KA	150 x 20 to 30 x H	80	10200
1	200 x 15 to 30 x H	50	4800
1A	200 x 15 to 30 x H	63, 80	6050/7650
4KA	200 x 15 to 30 x H	80	7650
1	250 x 20 to 25 x H	50	3850
1A	250 x 20 to 25 x H	63, 80	4850/6150
4KA	250 x 20 to 25 x H	80	6150



	mm						
H	6	10	16	20	22.23	25	32

Products of other dimensions can be made to special order.

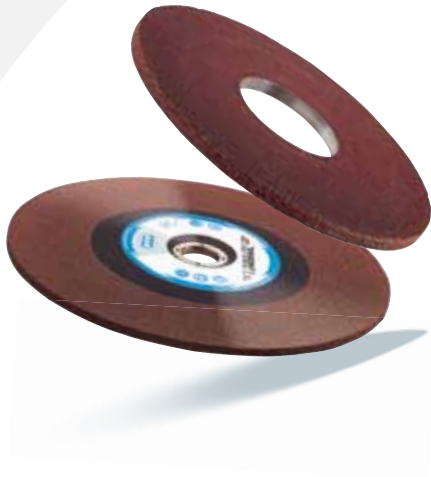
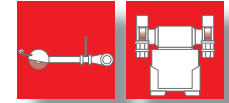

These grinding wheels are intended for use in various branches of industry for manual CLEANING OF CASTS on stable grinding machines.

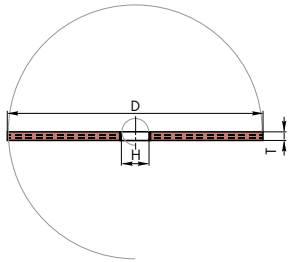

Specification	Hardness	Material	Quality class
3A20-36N-R3-4BF	Q-R	Steels	Standard
2ZA16-24N-R3-4BF	Q-R	Alloy steels	Special
53C20-36N-R3-4BF	Q-R	Stainless steels	Special
51C16-24N-R3-4BF	Q-R	Gray alloy	Standard
2ZA16-24N-R3-4BF	Q-R	Nodular alloy	Standard
9C16-24O-R3-4BF	P-Q	Aluminium, colour metals	Standard

Type	Dimensions D x T x H mm	Peripheral speed m/s	RPM 1/min
1A	300x 6 x H	80	5100
1A	300x 8 x H		5100
1A	300x 10 x H		5100
1A	350x 6 x H		4400
1A	350x 8 x H		4400
1A	350x 10 x H		4400
1A	350x 12 x H	63	3450
1A	350x 16 x H		3450
1A	350x 20 x H		3450
1A	400x 6 x H	80	3850
1A	400x 8 x H		3850
1A	400x 10 x H		3850
1A	400x 12 x H	63	3050
1A	400x 16 x H		3050
1A	400x 20 x H		3050
1A	450x 12 x H		2700
1A	450x 16 x H		2700
1A	450x 20 x H		2700
1A	500x 12 x H		2450
1A	500x 16 x H		2450
1A	500x 20 x H		2450
1A	600x 12 x H		2050
1A	600x 16 x H		2050
1A	600x 20 x H		2050

mm				
H	22.23	25	32	40 127

Products of other dimensions can be made to special order.



These grinding wheels are intended for use in various branches of industry for **COARSE GRINDING** on stable, manually operated suspended grinding machines and automatons.

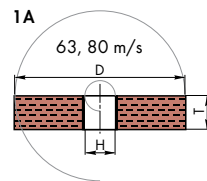
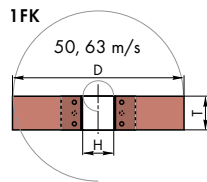
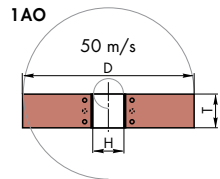

Specification	Hardness	Material	Quality class
3A14-24O-R3-4BF	Q-S	Non-alloy and low-alloy steels	Standard
52A7A16-24O-R3-4BF	Q-R	High-alloy steels	Standard
53C20-36N-R3-4BF	O-R	Stainless steel, high-alloy steel	Special
2ZA14-24N-R3-4BF	Q-R	Grey and nodular alloy	Standard
3A14-24Q-R3-4BF	Q-S	Tempered alloy	Standard
9C16-24O-P3-4BF	Q-R	Aluminium and other colour metals	Standard
52A16-24O-R3-4BF	Q-S	Stainless steel, steel, Casting	Special

Type	Dimensions D x T x H mm	Peripheral speed m/s	RPM 1/min
1A	300 x 12 to 60 x H	63, 80	4010/5100
1FK	300 x 30 to 60 x H	50, 63	3200/4050
1AO	300 x 30 to 60 x H	50	3200
1A	350 x 25 to 60 x H	63, 80	3440/4400
1FK	350 x 30 to 63 x H	50, 63	2750/3450
1AO	350 x 30 to 100 x H	50	2750
1A	400 x 30 to 60 x H	63, 80	3010/3850
1FK	400 x 25 to 76 x H	50, 63	2400/3050
1AO	400 x 30 to 60 x H	50	2400
1A	450 x 25 to 60 x H	63, 80	2670/3400
1FK	450 x 30 to 65 x H	50, 63	2150/2700
1AO	450 x 40 to 65 x H	50	2150
1A	500 x 50 to 60 x H	63, 80	2410/3100
1FK	500 x 30 to 80 x H	50, 63	1950/2450
1AO	500 x 40 to 76 x H	50	1950
1A	600 x 40 to 80 x H	63, 80	2000/2550
1FK	600 x 40 to 80 x H	50, 63	1600/2050
1AO	600 x 50 to 100 x H	50	1600
1FK	700 x 60 x H	50, 63	1360/1720
1FK	750 x 50 to 90 x H	50, 63	1270/1300
1FK	800 x 60 to 100 x H	50, 63	1190/1500

D mm	H mm							
300	25,4	30	32	40	50	60	76.2	127
350			32	40	50	60	76.2	127
400				40	50	60	76.2	127
450				40	50	60	76.2	127 150 152.4 200 203
500					50	60	76.2	127 150 152.4 200 203 250 305
600						60	76.2	127 150 152.4 200 203 250 305



These grinding wheels are intended for use in various branches of industry for COARSE GRINDING on stable, manually operated suspended grinding machines and automatons. They are distinguished by a high grinding efficiency and appropriate durability.

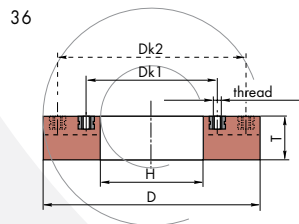
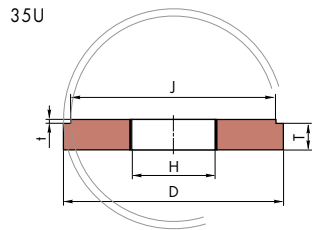

Specification	Hardness	Material	Quality class
52A36-60L-04-6B	G-J	Non- and low-alloy steels, magnets	Standard
4A24-60L-04-6B	L-N	Casting and fast-cutting steels	Standard
2A24-60L-04-6B	Q-R	Spring steel, low-alloy steels	Standard
52A14-36N-Q4-5B	R-S	Stainless steel, steel, casting	Special
2ZA14-24N-Q4-5B	P-Q	Grey and nodular casting	Standard
9C16-36L-04-5B	K-L	Aluminium and other colour metals	Standard
9C14-24L-04-6B	M-O	Lamellar and brake pads	Standard

Type	Dimensions D x T x H mm	Peripheral speed		Dk1/ No. of nuts	Dk2/ No. of nuts	Thread
		m/s	RPM 1/min			
35U	450 x 60 x 200/428 x 11	50	2150			
36	350 x 90 x 200		2750	280/10	/	M10
36	350 x 100 x 255		2750	300/8	/	M12
36	450 x 90 x 255	40	1700	375/10	/	M10
36	500 x 100 x 350		1550	456/24	/	M10
36	508 x 102 x 406	50	1900	456/24	/	M10
36	600 x 75 x 325	40	1300	530/12	380/6	M16
36	600 x 102 x 320	50	1600	530/12	380/6	M16
36	600 x 125 x 450		1600	588.8/12	508/6	M10



Products of other dimensions can be made to special order.



Ground material:	Grit	Grit size	Hardness	Structure	50 m/s	63 m/s
					Bond	Bond
 Non-ferrous metals	9C	16 - 24	O-P	4	B04	B05
 Steel						
Steel casts	52A, 3A, 7A	14 - 24	O-R	3 - 4	B04	B69
High-alloy steels	252A, 7A	16 - 24)	O-R	4	B04	B05
 Casting						
Grey alloy casts	2ZA, 53C	14 - 24	O-R	3 - 5	B13	B18
Nodular alloy casts	ZA, 52A	14 - 24	NM	4	B04	B05
Tempered alloy casts:						
- before tempering	2ZA, 53C, 9C	16 - 24	O-R	3 - 4	B68	B69
- after tempering	2ZA, 52A	16 - 24	N	4	B04	B05

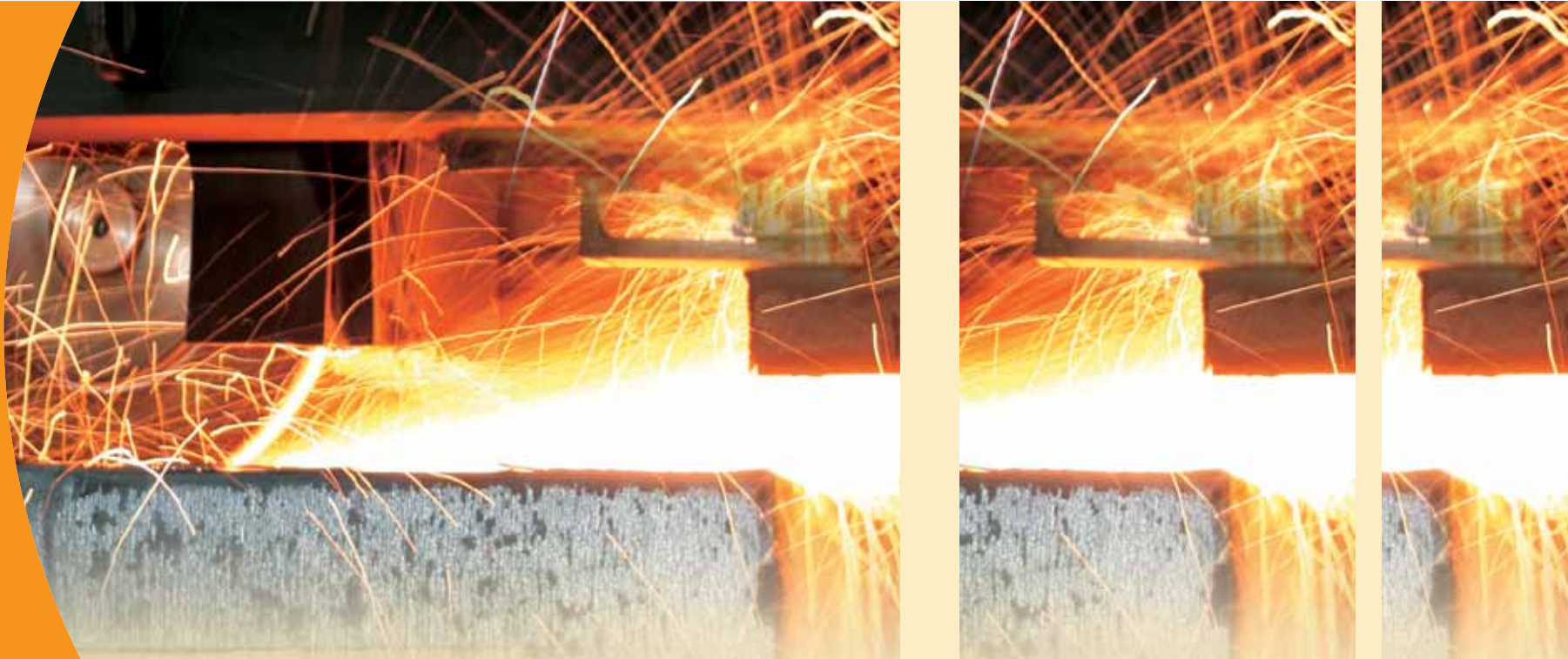



Grinding wheels 1VS

D x T x H

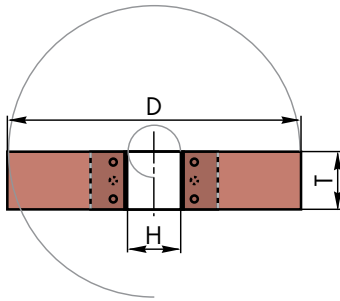

Hot-pressed grinding wheels are used for removal of hard oxide crust in the process of steel manufacture (slabs, billets) and rough grinding

Specification	Material
XA 10 Z B80	Carbon low-alloy steels
XA 16 Z B80	General applications
EA 14 Y B91	High-alloy steels (austenitic), stainless steels
EA 20 Y B91	High-alloy steel with higher roughness required
WA 10 Z B80	Machines with lower power ratings

Order printout sample:
 1VS 610x76x203.2
 EA 14 Y B91

Type	Dimensions D x T x H mm	Peripheral speed	
		m/s	RPM 1/min
1VS	610 x 65 x 203.2	80	2506
1VS	610 x 76 x 203.2, 304.8 (305)		2506
1VS	610 x 86 x 203.2		2506
1VS	610 x 102 x 304.8 (305)		2506
1VS	610 x 124 x 304.8 (305)		2506
1VS	920 x 100, 125, 150 x 304.8		1700
1VS	920 x 100, 125 x 400 or 406.4		1700

Cutting-off wheels 41..

D x T x H

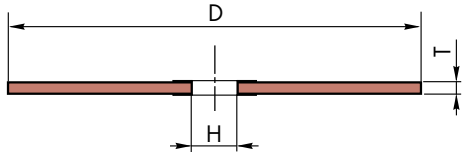

Order printout sampleF
 41C3D2K 1030x12/11x100
 5WA 20/2 S 7 BF83

D	T	H
450	4 - 4,5	25.4 (32) (40)
500	5 - 6	25.4 (32) (40)
600	6 - 7	40 (60) (76.2) (80)
800	9/8.5*	80 (100) (152.4)
1000	12/11*	100 (152.4)
1250	14/13*	127 (152.4)

* Conical reinforced cutting-off wheels



**Cutting-off wheels 42**

D x T x H

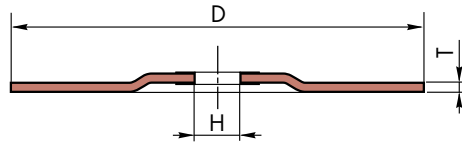

D	T	H
500	5 - 6	76,2
600	6 - 7	76,2

Reinforced cutting-off wheels of large diameters are used for cutting products of large cross-sections in the manufacture of rolled profiles, forged pieces, pipes and rods.

Cutting on suspended and stable machines

Workpiece	Specification	D
Structural steel	A24S1BF	450 - 600
Stone, firebrick	C30PB3BF	450 - 600
Aluminium and colour metals	A24PSBF	450 - 600
Stainless steel	4A3ON6BF	450 - 500
Stainless steel	7A24PBF	500 - 600
Steel and other alloys	WA24S1BF	500 - 600
Cutting of large cross-sections on stable machines	Cold cutting	WA20/24RBF
	Warm cutting	WA20/24SBF
	Hot cutting	WA20/24QBF



In the production and renewal of railway tracks, various types of grinding tools are used, depending on the place and the grinding method. These grinding wheels are intended for the maintenance of railway tracks as well as for grinding of welds and railway switchpoints on machines intended specifically for this purpose.

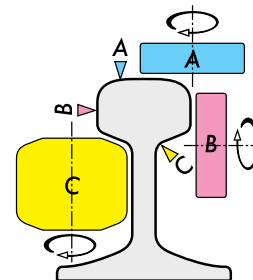

Zone A - railway track head
 Zone B - railway track lateral edge
 Zone C - web



Grinding wheels 1A

For railway track grinding – zone B
D x T x H

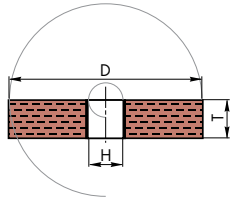

Type	Dimensions (mm)
1A	225x20x22.2
1A	230x20x22.2
1A	230x23x22.2
1A	230x25x22.2
1A	230x23x22.2
1A	230x12x22.2
1A	230x15x22.2
1A	230x21x22.2

STANDARD	EXTRA	SPECIAL
2ZA16/3 Q6BF10	2WA 20/9 Q 6 BX18/985	WA16/3Z+BX18

Grinding wheels 5A and 7A

For grinding of welds zone B
D x T x H - P x F

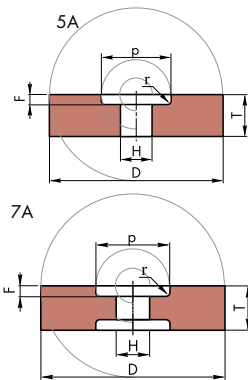

Type	Dimensions(mm)
5A	300x45x149-240x30
5A	254x25x25-150x18
5A	254x20x25-150x8
7A	250x40x76,2-166x10/10

STANDARD	EXTRA	SPECIAL
3A14P4B13	2WA 20/9 P6 BX18/985	WA16/3Z+BX18



Grinding cup 6

for grinding of welds zone A
D x T x H x E x W

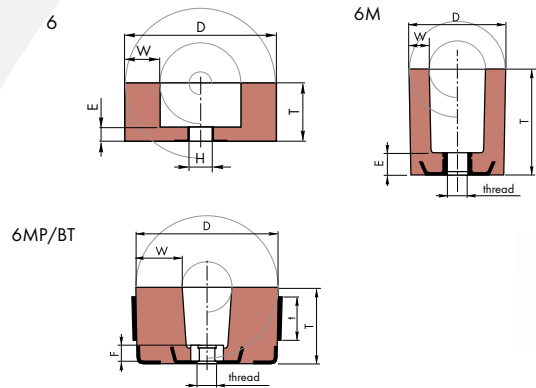

Type	Dimensions (mm)
6	100x110x22-W17E20
6M	100x110xM20-W20E20
6M	100x110xM20-W20E20
6M	100x110xM20L-W20E20
6M	125x65xM20-23P,W37,E12
6M	125x65xM20-23P,W37,E12
6M	125x65xM20-23P,W37,E12
6M	125x90xM20-23P, W37, E12
6MP/BT	150x80xU5/8''-20P-W49,5E20
6MP/BT	152x80xM20-20P-W51 E 20

STANDARD	EXTRA	SPECIAL
3A20/3P4B13, 2ZA16/3 Q6BF10	2WA 20/9 Q 6 BX18/985	WA16/3Z+BX18

Grinding cup 11

For grinding of railway track weld profile
D x T x H x W

Applications:
Manual grinding with an angle grinder (phy 180 mm) in places where machine grinding is not possible due to lack of access.

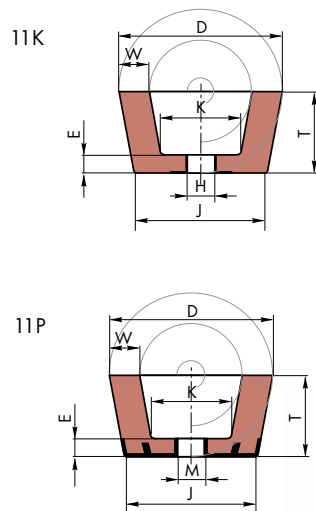

Type	Dimensions (mm)
11K 11P	110/90x55x22,2 - W20
11K 11P	110/90x55x22,2-W20

STANDARD	EXTRA
3A16/3P4B	3WA 20/9 s2 BX05

Products of other dimensions can be made to special order.



Grinding segment 31S..

For grinding of welds zone A
B/A x C x L

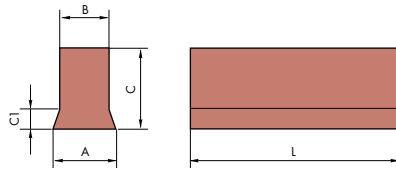

Type	Dimensions (mm)
31S28A-1	60/69x90x158
31S39	71/57x86x290
31S44	69.5/56x90x300

STANDARD	EXTRA
3A20 M4B	2WA 20/9 P6 BX18/985

Grinding ring 35

For grinding of welds zones A and B
D x T x H x E x W

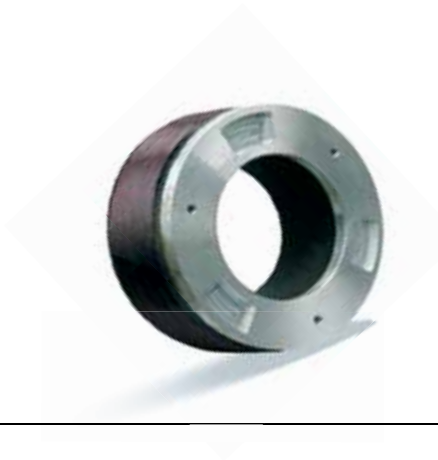
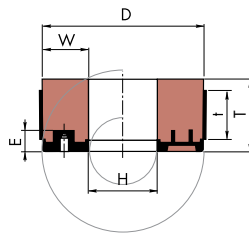

Type	Dimensions (mm)
35L	260 x 82 x 154
35L	260 x 82 x 154
35L	260x35x195
35/BT	180 x 105 x 90
35L	260x28x195
35L	280x30x210
35L	280x32x210

STANDARD	EXTRA	SPECIAL
ZA12/9 T6 B64	2WA 20/9 P6 BX18/985	WA16/3Z+BX18

Order printout sample:
35L 260x35x195
2WA 20/9 Q P6 BX18/985

Grinding wheels 7Y2

For grinding of zone C
D x T x H - P x F

Applications:
Grinding of connecting chambers
with machines intended
specifically for this purpose.

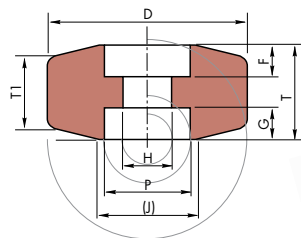

Type	Dimensions (mm)
7Y2-5	135 x 95/70 x 25,4 - 55 x 30/30 - R17 V14
7Y2-11	135x74/61x25,4 20/20-R8V12,5
7Y2-10	135x74/61x25,4S-55x22,5/22,5

STANDARD	EXTRA	SPECIAL
3A20Q4B	57A24/3P4B13S	2WA 20/9 P6 BX18/985

Grinding wheels 36

for grinding of welds zone A
D x T x H

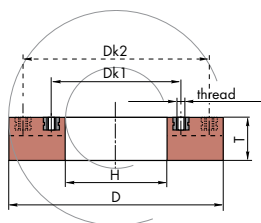

Type	Dimensions (mm)
36/5	150x72x57-4/M8-15A
36/5	150x75x57-4/M8-15A
36/5	150x75x57-4/M8-15A
36/2	125x60x55-4/M8-15A
36/2	125x60x55-4/M8-15A
36/2	125x60x55-4/M8-15A

Order printout sample:

36/5 150x72x57-4/M8-15A

2WA 20/9 Q 6 BX18/985

STANDARD	EXTRA	SPECIAL
3A20/3P4B13, 2ZA16/3 Q6BF10	2WA 20/9 Q 6 BX18/985	WA16/3Z+BX18

**Cutting-off wheels 41**

D x T x H



These cutting-off wheels are intended for free-hand cutting, making of isolation cuts, welded gap preparation, railway track coating, etc.



Type	Dimensions D x T x H mm	Peripheral speed m/s	RPM 1/min	Reinf.	Package unit pz
41	300 x 3 x H	80	5100	E	25
41	300 x 4 x H	100	6400	E	
41	350 x 3 x H	80	4400	E	10
41	350 x 4 x H	100	5500	E	
41	400 x 3 x H	80	3850	E	
41	400 x 4 x H	100	4800	E	

mm

H	20	22,23	25,4

Upon customer request, cutting-off wheels may be produced with a hole (H) as per agreement.

STANDARD	EXTRA	SPECIAL
3ZA24P-BF	45A24Q-BF	74A20R-BF







Grinding cup 6

D x T x H - W..E..

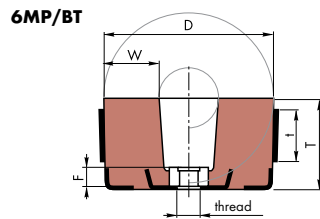
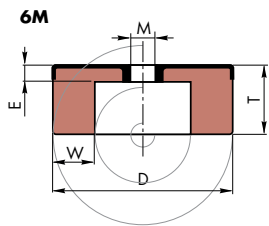
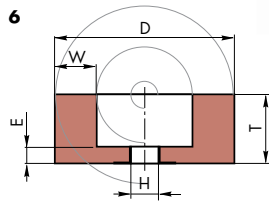

Thread: M14,M20,M20L, W5/8", 5/8"UNC,
Type BT: reinforced with fiberglass

Order printout sample:
6M/BT 100x110xM14-25..20..
ZA 20 P

Specification	Hardness	Material	Quality class
C, 9C	H-S	Concrete, stone, granite, grey cast, fire-resist.brick	standard
52A, 2A,8A,4A.6A,8A	E-K	Steel - alloy and non-alloy	standard
8A	E-I	HSS	standard
2A,42A	G-H	HSS	standard
2A, 8A	F-J	Stainless steel	standard
2A, 8A,C	G-I	Hard chrome plants	standard
C, 9C	H-J	Colour metals , Aluminium	standard
9C	K	Plastics	standard
ZA, WA	P-Z	Steel - alloy and non-alloy	special

Type	D x T x H mm	W mm	E mm	Periph. speed m/s
6	50x50x20	10	10	35
6	60x40x20	10	10	32
6	75x50x32	8.5	10	35
6	80x30x20	12	10	32
6	80x50x20	10	10	25
6	100x60x51	4.5	15	32
6	100x85x20	24	25	50
6	100x80x51	18.7	20	50
6	100x110x22	18.7	20	50
6	125x45x16	10	10	32
6	125x63x20	6	13	35
6	125x100x20	20	16	35
6	160x80x22,2	20	20	25
6	175x75, 100x76	15	15	35
6	200x100x76	30	25	35
6M	80x70xThread	20	17, 20	50
6M	90x65, 85xThread	19	20	
6M	90x75xThread	25	20	
6M	90x85xThread	30	20	
6M	90x100, 110xThread	20	20	
6M	100x45, 85, 110xThread	20	20	
6M	118x55xThread	30	20	
6M	125x55xThread	25	20	
6M	125x55xThread	37, 42.5	12	
6M	125x65xThread	37	20	
6M	130x45, 55xThread	37	20	
6M	150x40, 55xThread	40	20	
6M	152x65xThread		20	
6M/BT	100x110xThread	25	20	
6MP/BT	150x57xThread	20	20	
6MP/BT	150x68xThread	40	20	
6MP/BT	150x80xThread	51	20	

Grinding cup 11

D/J x T x H - W..E..K..

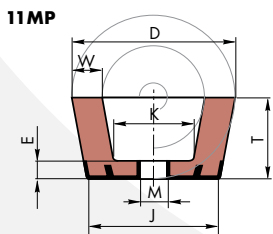
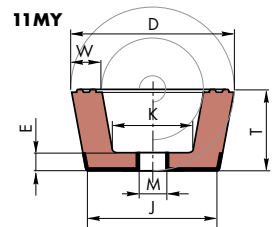
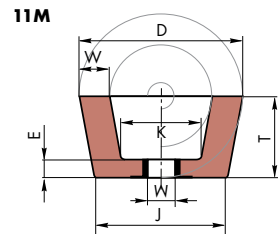
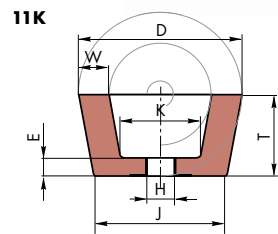

Specification	Hardness	Material	Quality class
9C16-9C220	L-S	Concrete, stone, granite	standard
3A16-3A120	L-S	Metals, steel, construction steel	standard
ZA16-Za24	P-S	Metals, steel, construction steel	special
WA14-WA24	P-S	Metals, steel, construction steel	special

Type	D x T x H mm	J mm	W mm	E mm	Periph. speed m/s
11K	110/94x55x22.2	94	20	11	50
11KY	110/94x55x22.2	94	20	11	
11K	140/115x65x22.2	115	25	20	
11P	76/64x40x22.2	64	12	11	
11P	110/90x55x22.2	90	20	12	
11P	130/90xx55x22.2	90	31	12	
11P	110/90xx55x22.2	90	20	11	
11PY	130/90xx55x22.2	90	31	12	
11M	110/90x55x Thread	90	20	13	
11M	125/90x52x Thread	90	25	20	
11M	130/94x52x Thread	94	31	13	
11M	150/120x52x Thread	120	30	20	
11MY	110/90x55x Thread	90	20	13	
11MY	130/94x55x Thread	94	20	13	
11MP	76/64x40x Thread	64	12	11	
11MP	102/70x51x Thread	70	18	12	
11MP	110/90x55x Thread	90	20	12	
11MP	125/90x52x Thread	90	25	20	
11MP	127/96x62x Thread	96	51	20	
11MP	130/90x55x Thread	90	30	12	
11MP	150/120x51x Thread	120	31	20	

Thread: M10, M14, 5/8"Unc, 5/8"W



Grinding cups should ALWAYS be fastened on angle grinding machines using a special safety shield!

INCORRECT HANDLING

1. DON'T store wheels in a damp atmosphere or in extreme temperatures.
2. DON'T use non-reinforced cutting-off wheels on portable machines.
3. DON'T handle wheels roughly.
4. DON'T mount a damaged wheel.
5. DON'T EVER exceed the maximum operating speed marked on the wheel.
6. DON'T force a wheel onto a machine spindle.
7. DON'T use mounting flanges which are incorrect, damaged, dirty or worn out.
8. DON'T tighten the mounting nut or locking flange excessively. This can distort the flanges.
9. DON'T use blotters for soft mounting of depressed-centre concave wheels.
10. DON'T use a machine which is not in good mechanical condition.
11. DON'T use a machine without a wheel guard.
12. DON'T use wheels without proper ventilation or dust protection equipment.
13. DON'T apply side pressure to cutting-off wheels.
14. DON'T stop the wheel after use by applying pressure to the wheel edge or side. Always switch the machine off and allow the wheel to stop revolving.
15. DON'T allow the wheel to be trapped or pinched in the cut.
16. DON'T apply excessive pressure onto the wheel so that the driving motor slows down.
17. DON'T grind on the side of cutting-off wheels.
18. DON'T drop portable machines or lower to the floor by the cable or air hose. A wheel can be easily cracked by the weight of the machine if it is put down hard. This is a common cause of wheel breakage.
19. DON'T grind with a depressed-centre concave grinding wheel at an angle lower than the prescribed angle.
20. DON'T use a machine in a position where you do not have full control of the machine and you are not well balanced.

CORRECT HANDLING

1. DO always follow instructions for correct storage.
2. DO always visually inspect grinding wheels before mounting for possible damage during transport and eliminate damaged ones.
3. DO always use a safety guard, which should cover nearly one half of the grinding wheel.
4. DO always use non-reinforced cutting-off wheels on fixed stationary machines.
5. DO always switch off the power at the supply and/or unplug the machine before changing the wheel.
6. DO always use the tools supplied by the machine manufacturer to change the wheel.
7. DO always ensure that the spindle speed of the machine is no higher than the operating speed marked on the wheel.
8. DO always use the correct wheel mounting flanges for grinding wheels and check that they are undamaged, clean and free of burrs.
9. DO always use blotters between the mounting flanges and the wheel sides for soft mounting of flat cutting-off wheels.
10. DO always allow newly mounted wheels to run at operating speed with the guard in place for at least one minute before cutting or grinding.
11. DO always wear protective gear: safety clothing, dust masks, eye protection (glasses or shield), gloves and ear protection.
12. DO have machine speeds checked regularly, especially after maintenance or repair.
13. DO always check the tension of the driving belt, where fitted, on a regular basis: belts must be kept tight in order to ensure optimum power transmission.
14. DO always secure the workpiece firmly before beginning cutting or grinding.
15. DO store portable machines appropriately when not being used, to avoid accidental physical damage to the wheel.
16. DO always use portable machines in a comfortable position, where the body is well balanced and the machine is well supported.
17. DO grind at the prescribed angle to the item with depressed-centre grinding wheels on an angle grinding machine.
18. DO always keep the work space around cutting and grinding operations clear. It is very dangerous if an operator slips or falls during cutting or grinding operations.

Please store in dry and well-ventilated premises without major temperature changes (temperatures between 10° and 30°C and max. 70 % relative humidity).

This will help preserve the physical properties of reinforced resin bonded grinding wheels for up to three years, up to two years for non-reinforced ones.

The storage premises should be as close to the place of use as possible in order to avoid mechanical damage to the wheels during transport, as well as moisture condensation while in transit on colder days.

Please use appropriate stands, shelves, drawers and boxes for storing various types of grinding wheels.

- Store wide thin-section grinding wheels in a horizontal position on a flat surface or on a steel base.
- Place thinner resin bonded cutting-off wheels on a flat surface in order to prevent bending.
- Store small grinding wheels on upper shelves or in their original packaging.
- Store depressed-centre concave grinding wheels one on top of the other or in their original packaging, up to a stack height of 120 cm.
- Store grinding wheels and thick-section grinding rings of larger dimensions vertically on lower shelves, but transport them horizontally.

Vitrified bonded grinding wheels are not sensitive to atmospheric influences. Due to their fragility, they are however very sensitive to impact, because this causes cracks that are undetectable by the human eye, but may cause grinding wheel rupture at the beginning of work. Grinding wheels should be stored on wooden shelves that prevent rolling. The shelves need to be designed such that various grinding tool types can be arranged on them simple and safe manner.

Easy and safe removal of grinding tools from the shelves should also be ensured, while maintaining the stability of those remaining on the shelves. Grinding tool shelving should be positioned as close to the grinding machine as possible.

On the other hand, the quality of resin bonded grinding wheels gradually deteriorates. This process may be accelerated by unsuitable storage conditions. Resin bonded grinding wheels should not be allowed to freeze. The storage temperature should be between 10° and 30° C, and the relative humidity should not exceed 70%. Under such conditions, the physical properties of these grinding wheels remain unchanged for a year. After prolonged storage, however, the mechanical properties of the grinding wheels may change, therefore safety checks should be performed prior to their use.





SWATYCOMET, umetni brusi in nekovine, d.o.o.
Titova cesta 60, 2000 Maribor, Slovenia
t: +386 (0)2 3331 600, (0)3 7575 000
f: +386 (0)2 3331 790, (0)3 7575 100
www.swatycomet.si, e: info@swatycomet.si



Toroflex Schleifmittel, GmbH
Esbachgraben 17, 95463 Bindlach - Germany



Ecopack, d.o.o.
Tovarniška 5, 3214 Zreče - Slovenia

